

COMMENSURABILITY FOR CERTAIN RIGHT-ANGLED COXETER GROUPS AND GEOMETRIC AMALGAMS OF FREE GROUPS

PALLAVI DANI, EMILY STARK AND ANNE THOMAS

ABSTRACT. We give explicit necessary and sufficient conditions for the abstract commensurability of certain families of 1-ended, hyperbolic groups, namely right-angled Coxeter groups defined by generalized Θ -graphs and cycles of generalized Θ -graphs, and geometric amalgams of free groups whose JSJ graphs are trees of diameter ≤ 4 . We also show that if a geometric amalgam of free groups has JSJ graph a tree, then it is commensurable to a right-angled Coxeter group, and give an example of a geometric amalgam of free groups which is not commensurable to any group which is finitely generated by torsion elements. Our proofs involve a new geometric realization of the right-angled Coxeter groups we consider, such that covers corresponding to torsion-free, finite-index subgroups are surface amalgams.

1. INTRODUCTION

Two groups G and H are (*abstractly*) *commensurable* if they contain finite-index subgroups $G' < G$ and $H' < H$ so that G' and H' are abstractly isomorphic. There are related but stronger notions of commensurability for subgroups of a given group. Commensurability in the sense we consider is an equivalence relation on abstract groups which implies quasi-isometric equivalence (for finitely generated groups). In this paper, we give explicit necessary and sufficient conditions for commensurability within certain families of Coxeter groups and amalgams of free groups.

Let Γ be a finite simplicial graph with vertex set S . The *right-angled Coxeter group* W_Γ with *defining graph* Γ has generating set S and relations $s^2 = 1$ for all $s \in S$, and $st = ts$ whenever $s, t \in S$ are adjacent vertices. We assume throughout that W_Γ is infinite, or equivalently, that Γ is not a complete graph. The graph Γ is *3-convex* if every path between a pair of vertices of valence at least three in Γ has at least three edges. For each induced subgraph Λ of Γ , with vertex set A , the corresponding *special subgroup* of W_Γ is the right-angled Coxeter group $W_\Lambda = W_A = \langle A \rangle$. See Section 2.1 for additional terminology for graphs, and Figure 1.1 for some examples of 3-convex defining graphs.

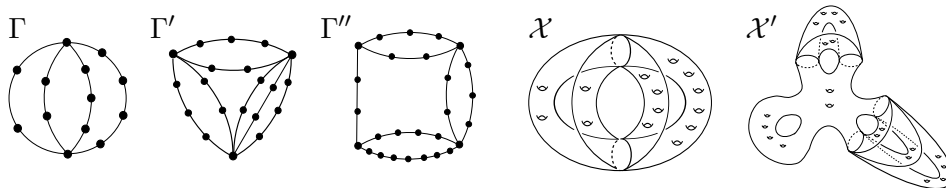

FIGURE 1.1. The graphs Γ , Γ' , and Γ'' are examples of 3-convex defining graphs, and the spaces \mathcal{X} and \mathcal{X}' are examples of surface amalgams.

Geometric amalgams of free groups were introduced by Lafont in [16]. These are fundamental groups of spaces called *surface amalgams*, which, roughly speaking, consist of surfaces with boundary glued together along their boundary curves. See Section 2.3 for details, and Figure 1.1 for some examples.

We now outline our main results and the ideas of their proofs, including some new constructions which may be of independent interest, and discuss previous work on related questions. We defer precise definitions and theorem statements to Section 1.1.

In Theorems 1.8 and 1.12, we give explicit necessary and sufficient conditions for commensurability of right-angled Coxeter groups defined by two families of graphs. Theorem 1.8 classifies those defined by 3-convex *generalized Θ -graphs* (see Definition 1.6 and the graph Γ in Figure 1.1), and Theorem 1.12 classifies those defined by 3-convex *cycles of generalized Θ -graphs* (see Definition 1.10 and the graphs Γ' and Γ'' in Figure 1.1). We prove Theorem 1.8 in Section 5, and the necessary and sufficient conditions of Theorem 1.12 in Sections 6 and 7, respectively. Our commensurability criteria are families of equations involving the Euler characteristics of certain special subgroups, and we express these criteria using commensurability of vectors with entries determined by these Euler characteristics.

In [6], Crisp and Paoluzzi classified up to commensurability the right-angled Coxeter groups defined by a certain family of three-branch generalized Θ -graphs, and in Remark 1.9 we recover their result using Theorem 1.8. If Γ is a 3-convex generalized Θ -graph and Γ' a 3-convex cycle of generalized Θ -graphs, we can also determine the commensurability of W_Γ and $W_{\Gamma'}$, as explained in Remark 1.14.

The results described in the previous two paragraphs fit into a larger program of classifying 1-ended, hyperbolic right-angled Coxeter groups up to commensurability. Since groups that are commensurable are quasi-isometric, a step in this program is provided by Dani and Thomas [7], who considered Bowditch’s JSJ tree [3], a quasi-isometry invariant for 1-ended hyperbolic groups which are not cocompact Fuchsian. If G is such a group then G acts cocompactly on its Bowditch JSJ tree \mathcal{T}_G with edge stabilizers maximal 2-ended subgroups over which G splits. The quotient graph for the action of G on \mathcal{T}_G is called the *JSJ graph of G* , and the induced graph of groups is the *JSJ decomposition for G* . In Section 2.2, we recall results from [7] that give an explicit “visual” construction of the JSJ decomposition for right-angled Coxeter groups W_Γ satisfying the following.

Assumption 1.1. The graph Γ has no triangles (W_Γ is 2-dimensional); is connected and has no separating vertices or edges (W_Γ is 1-ended); has no squares (W_Γ is hyperbolic); is not a cycle of length ≥ 5 (W_Γ is not cocompact Fuchsian); and Γ has a cut pair of vertices $\{a, b\}$ (W_Γ splits over a 2-ended subgroup).

Moreover, Theorem 1.3 of [7] says that Bowditch’s tree is a *complete* quasi-isometry invariant for the family of groups satisfying, in addition,

Assumption 1.2. Γ has no induced subgraph which is a subdivided copy of K_4 .

We denote by \mathcal{G} the family of graphs satisfying Assumptions 1.1 and 1.2. Generalized Θ -graphs and cycles of generalized Θ -graphs are two infinite families of graphs in \mathcal{G} . Thus Theorems 1.8 and 1.12 and Remarks 1.9 and 1.14 provide a finer classification (up to commensurability) within some quasi-isometry classes determined by graphs in \mathcal{G} . In Section 9 we discuss the obstructions to extending our results to other families of graphs in \mathcal{G} .

Our proofs of the necessary conditions in Theorems 1.8 and 1.12 follow the same general strategy used by Crisp–Paoluzzi [6] and Stark [23] on commensurability of certain geometric amalgams of free groups (discussed further below). Given two groups which are commensurable, the first step

in both these papers is to consider covers corresponding to isomorphic (torsion-free) finite-index subgroups. In both cases such covers are surface amalgams, and a crucial ingredient is Lafont’s topological rigidity result from [16], which says that any isomorphism between a pair of geometric amalgams of free groups is induced by a homeomorphism of the corresponding surface amalgams. This homeomorphism between the covers is then analyzed to obtain the necessary conditions.

The natural spaces to apply this strategy to in our setting are quotients Σ_Γ/G where Σ_Γ is the Davis complex for W_Γ , and G is a torsion-free, finite-index subgroup of W_Γ . However, Stark proves in [22] that topological rigidity fails for such quotients, by constructing an example where G and G' are isomorphic torsion-free, finite-index subgroups of W_Γ , but Σ_Γ/G and Σ_Γ/G' are not homeomorphic. The graph Γ in this example is a 3-convex cycle of generalized Θ -graphs.

In light of the result of [22], in Section 3 we introduce a new geometric realization for right-angled Coxeter groups W_Γ with 3-convex $\Gamma \in \mathcal{G}$, by constructing a piecewise hyperbolic orbicomplex \mathcal{O}_Γ with fundamental group W_Γ . The orbicomplex \mathcal{O}_Γ has underlying space obtained by gluing together right-angled hyperbolic polygons, and each edge of \mathcal{O}_Γ which is contained in only one such polygon is a reflection edge. It follows that any cover of \mathcal{O}_Γ corresponding to a torsion-free, finite-index subgroup of W_Γ is a surface amalgam (tiled by right-angled polygons). Thus we can apply Lafont’s result to these spaces. With a view to generalizing the commensurability classification, we give the construction of the orbicomplex \mathcal{O}_Γ for all 3-convex graphs in \mathcal{G} , not just for generalized Θ -graphs and cycles of generalized Θ -graphs.

Our construction of \mathcal{O}_Γ makes heavy use of the JSJ decomposition from [7]. We restrict to 3-convex defining graphs in this paper so that the correspondence between Γ and the JSJ decomposition of W_Γ is more straightforward than the general case in [7]. A reference for orbifolds is Kapovich [15]; we view orbicomplexes as complexes of groups, and use the theory of these from Bridson–Haefliger [4].

The proofs of the necessary conditions in Theorems 1.8 and 1.12 then involve a careful analysis of the homeomorphic finite covers guaranteed by topological rigidity. For generalized Θ -graphs, we adapt Stark’s proof in [23] to the setting where the orbicomplexes considered do not have the same Euler characteristic. The proof of the necessary conditions for cycles of generalized Θ -graphs is considerably more difficult. Here, the groups W_Γ and $W_{\Gamma'}$ are fundamental groups of orbicomplexes \mathcal{O}_Γ and $\mathcal{O}_{\Gamma'}$ with “central” orbifolds \mathcal{A} and \mathcal{A}' that have many branching edges along which other orbifolds are attached (see the lower right of Figure 4.4). A key ingredient in the proof of Theorem 1.12 is a careful argument to show that the homeomorphism $f : \mathcal{X} \rightarrow \mathcal{X}'$ between finite covers $\pi : \mathcal{X} \rightarrow \mathcal{O}_\Gamma$ and $\pi' : \mathcal{X}' \rightarrow \mathcal{O}_{\Gamma'}$ guaranteed by Lafont’s topological rigidity result can be modified so that either $f(\pi^{-1}(\mathcal{A})) = \pi'^{-1}(\mathcal{A}')$, or $f(\pi^{-1}(\mathcal{A}))$ has no surfaces in common with $\pi'^{-1}(\mathcal{A}')$.

To prove the sufficient conditions in Theorem 1.8 and 1.12, given any pair of groups W_Γ and $W_{\Gamma'}$ which satisfy the putative sufficient conditions, we construct finite-sheeted covers of \mathcal{O}_Γ and $\mathcal{O}_{\Gamma'}$ with isomorphic fundamental groups. It follows that W_Γ and $W_{\Gamma'}$ have isomorphic finite-index subgroups. In the case of generalized Θ -graphs, these finite-sheeted covers are orbicomplexes whose construction is an immediate generalization of Crisp and Paoluzzi’s. The finite covers in the case of cycles of generalized Θ -graphs are homeomorphic surface amalgams, and their construction is quite delicate.

In order to explain our constructions of surface amalgams covering \mathcal{O}_Γ , we introduce the notion of a *half-covering* of graphs (see Section 4.1). The idea is that if a surface amalgam \mathcal{Y} is a finite-sheeted cover of another surface amalgam \mathcal{X} , or of an orbicomplex \mathcal{O}_Γ , then the induced map of JSJ graphs is a half-covering. For the proofs of the sufficient conditions in Theorem 1.12, we first construct the JSJ graphs for the homeomorphic finite-sheeted covers, together with the associated

half-coverings. We then construct suitable surfaces and glue them together along their boundaries, guided by adjacencies in the JSJ graphs, to obtain a surface amalgam covering \mathcal{O}_Γ .

One construction in our proof of sufficient conditions for Theorem 1.12 may be of independent interest. In Section 4, given any orbicomplex \mathcal{O}_Γ (with $\Gamma \in \mathcal{G}$ and Γ being 3-convex), we construct a particularly nice degree 16 cover \mathcal{X} which is a surface amalgam. Hence W_Γ has an index 16 subgroup which is a geometric amalgam of free groups (this result is stated below as Theorem 1.15). Our construction of \mathcal{X} uses tilings of surfaces similar to those in Futer and Thomas [10, Section 6.1]. Given two groups W_Γ and $W_{\Gamma'}$ which satisfy the sufficient conditions from Theorem 1.12, we first pass to our degree 16 covers \mathcal{X} and \mathcal{X}' of \mathcal{O}_Γ and $\mathcal{O}_{\Gamma'}$, then construct homeomorphic finite-sheeted covers of \mathcal{X} and \mathcal{X}' .

Theorem 1.16, proved in Section 8, says that for all geometric amalgams of free groups G , if the JSJ graph of G is a tree, then G is commensurable to some W_Γ (with $\Gamma \in \mathcal{G}$). In Section 8 we also give an example of a geometric amalgam of free groups which is not commensurable to any W_Γ , or indeed to any group finitely generated by torsion elements. This leads to the question:

Question 1.3. Which geometric amalgams of free groups are commensurable to right-angled Coxeter groups (with defining graphs in \mathcal{G})?

The proof of Theorem 1.16 uses the torsion-free degree 16 cover of the orbicomplex \mathcal{O}_Γ that we construct in Section 4. We show that any surface amalgam whose JSJ graph is a tree admits a finite-sheeted cover which “looks like” our torsion-free cover. Then we follow our construction in Section 4 backwards to obtain an orbicomplex \mathcal{O}_Γ as a finite quotient, with fundamental group the right-angled Coxeter group W_Γ .

As a corollary to Theorems 1.8, 1.12, and 1.16, we obtain the commensurability classification of geometric amalgams of free groups whose JSJ graph is a tree with diameter at most 4 (see Corollary 1.17). This recovers Theorem 3.31 of Stark [23], which gives the commensurability classification of fundamental groups of surface amalgams obtained by identifying two closed surfaces along an essential simple closed curve in each. We remark that Malone [18] provides a complete quasi-isometry classification within the class of geometric amalgams of free groups; in particular, he proves that the isomorphism type of Bowditch’s JSJ tree for such a group is a complete quasi-isometry invariant, and supplies an algorithm to compute this tree.

We conclude this part of the introduction by mentioning some earlier work on commensurability, and on the relationship between commensurability and quasi-isometry, for groups closely related to the ones we study. We refer to the surveys by Paoluzzi [21] and Walsh [24] for more comprehensive accounts. In [14] and [11], the related notion of wide commensurability is studied for Coxeter groups generated by reflections in the faces of polytopes in n -dimensional real hyperbolic space. Apart from these two papers and [6], we do not know of any other work on commensurability for (infinite non-affine) Coxeter groups.

In [5], Crisp investigated commensurability in certain 2-dimensional Artin groups, while Huang has studied quasi-isometry and commensurability in right-angled Artin groups with finite outer automorphism groups in [13] and [12]. Huang’s combined results show that within a class of right-angled Artin groups defined by a few additional conditions on the defining graph, the quasi-isometry, commensurability and isomorphism classes are the same. We note that none of the groups we consider is quasi-isometric to a right-angled Artin group, since the groups we consider are all 1-ended and hyperbolic, and a right-angled Artin group is hyperbolic if and only if it is free.

The above results of Huang are in contrast to our settings of right-angled Coxeter groups and geometric amalgams of free groups: Theorems 1.8, 1.12, and 1.16 above, together with the descriptions of Bowditch’s JSJ tree from [7] and [18], show that each quasi-isometry class containing one

of the groups considered in our theorems contains infinitely many commensurability classes. For geometric amalgams of free groups, Malone [18] and Stark [23] had both given examples to show that commensurability and quasi-isometry are different.

1.1. Definitions and statements of results. We now give precise definitions and statements for our main results.

First, we recall the definition of the Euler characteristic of a Coxeter group, in the case we will need. A reference for the general definition is pp. 309–310 of [8].

Definition 1.4 (Euler characteristic of W_Γ). Let W_Γ be a right-angled Coxeter group with defining graph Γ having vertex set $V(\Gamma)$ and edge set $E(\Gamma)$. Assume that Γ is triangle-free. Then the *Euler characteristic* of W_Γ is the rational number $\chi(W_\Gamma)$ given by:

$$\chi(W_\Gamma) = 1 - \frac{\text{card } V(\Gamma)}{2} + \frac{\text{card } E(\Gamma)}{4}.$$

We remark that $\chi(W_\Gamma)$ is equal to the Euler characteristic of the orbicomplex induced by the action of W_Γ on its Davis complex (we will not need this interpretation).

To each group we consider, we associate a collection of vectors involving the Euler characteristics of certain special subgroups. We will use the following notions concerning commensurability of vectors.

Definition 1.5 (Commensurability of vectors). Let $k, \ell \geq 1$. Vectors $v \in \mathbb{Q}^k$ and $w \in \mathbb{Q}^\ell$ are *commensurable* if $k = \ell$ and there exist integers K and L so that $Kv = Lw$. Given a nontrivial commensurability class \mathcal{V} of vectors in \mathbb{Q}^k , the *minimal integral element* of \mathcal{V} is the unique vector $v_0 \in \mathcal{V} \cap \mathbb{Z}^k$ so that the entries of v_0 have greatest common divisor 1 and the first nonzero entry of v_0 is a positive integer. Then for each $v \in \mathcal{V}$, there is a unique rational $R = R(v)$ so that $v = Rv_0$.

Our first main result, Theorem 1.8, classifies the commensurability classes among right-angled Coxeter groups with defining graphs generalized Θ -graphs, defined as follows.

Definition 1.6 (Generalized Θ -graph). For $k \geq 1$, let Ψ_k be the graph with two vertices a and b , each of valence k , and k edges e_1, \dots, e_k connecting a and b . For integers $0 \leq n_1 \leq \dots \leq n_k$, the *generalized Θ -graph* $\Theta(n_1, n_2, \dots, n_k)$ is obtained by subdividing the edge e_i of Ψ_k into $n_i + 1$ edges by inserting n_i new vertices along e_i , for $1 \leq i \leq k$.

For example, the graph Γ in Figure 1.1 is $\Theta(2, 2, 3, 4)$. We write β_i for the induced subgraph of $\Theta = \Theta(n_1, n_2, \dots, n_k)$ which was obtained by subdividing the edge e_i of Ψ_k , and call β_i the *i 'th branch* of Θ . A generalized Θ -graph is 3-convex if and only if $n_i \geq 2$ for all i , equivalently $n_1 \geq 2$. Note that if Θ is 3-convex and has at least 3 branches then Θ satisfies Assumptions 1.1 and 1.2.

To each generalized Θ -graph, we associate the following Euler characteristic vector.

Definition 1.7 (Euler characteristic vector for generalized Θ -graphs). Let W_Θ be the right-angled Coxeter group with defining graph $\Theta = \Theta(n_1, \dots, n_k)$. The *Euler characteristic vector* of W_Θ is $v = (\chi(W_{\beta_1}), \dots, \chi(W_{\beta_k}))$.

Note that, by definition, $\chi(W_{\beta_1}) \geq \dots \geq \chi(W_{\beta_k})$. For example, if $\Gamma = \Theta(2, 2, 3, 4)$ as in Figure 1.1, then the Euler characteristic vector of W_Γ is $v = (-\frac{1}{4}, -\frac{1}{4}, -\frac{1}{2}, -\frac{3}{4})$.

The commensurability classification for the corresponding right-angled Coxeter groups is then as follows.

Theorem 1.8. *Let Θ and Θ' be 3-convex generalized Θ -graphs with at least 3 branches, and let v and v' be the Euler characteristic vectors of the right-angled Coxeter groups W_Θ and $W_{\Theta'}$, respectively. Then W_Θ and $W_{\Theta'}$ are abstractly commensurable if and only if v and v' are commensurable.*

Remark 1.9. We now explain how Theorem 1.8 can be used to classify all right-angled Coxeter groups defined by generalized Θ -graphs satisfying Assumptions 1.1 (so that the corresponding groups are 1-ended and hyperbolic), with Θ not required to be 3-convex.

If $\Theta = \Theta(n_1, \dots, n_k)$ satisfies every condition in Assumptions 1.1, it is easy to check that $k \geq 3$, $n_1 \geq 1$, and $n_i \geq 2$ for all $i \geq 2$. Theorem 1.8 covers the case $n_1 \geq 2$, so we just need to discuss the case $n_1 = 1$.

Let c be the unique vertex of valence 2 on the first branch of Θ . Then we may form the *double of Θ over c* , defined by $D_c(\Theta) = \Theta(n_2, n_2, n_3, n_3, \dots, n_k, n_k)$. This is a 3-convex generalized Θ -graph with $2(k-1) \geq 4$ branches, obtained from Θ by deleting the open star of c , and then identifying two copies of the resulting graph along a and b . The group $W_{D_c(\Theta)}$ is isomorphic to the kernel of the map $W_\Theta \rightarrow \mathbb{Z}/2\mathbb{Z}$ which sends c to 1 and all other generators to 0. In particular, $W_{D_c(\Theta)}$ is commensurable to W_Θ . This, together with Theorem 1.8, can be used to extend our classification result above to all generalized Θ -graphs satisfying Assumptions 1.1. In this way we recover Crisp and Paoluzzi's result from [6], as they considered the family of graphs $\Theta(1, m+1, n+1)$ with $m, n \geq 1$.

Next, in Theorem 1.12 we consider groups W_Γ where Γ is a cycle of generalized Θ -graphs, defined as follows.

Definition 1.10 (Cycle of generalized Θ -graphs). Let $N \geq 3$ and let r_1, \dots, r_N be positive integers so that for each i , at most one of r_i and $r_{i+1} \pmod{N}$ is equal to 1. Now for $1 \leq i \leq N$, let Ψ_{r_i} be the graph from Definition 1.6, with r_i edges between a_i and b_i . Let Ψ be the graph obtained by identifying b_i with a_{i+1} for all $i \pmod{N}$. A *cycle of N generalized Θ -graphs* is a graph obtained from Ψ by (possibly) subdividing edges of Ψ .

For example, the graph Γ' (respectively, Γ'') in Figure 1.1 is a cycle of three (respectively, four) generalized Θ -graphs. If Γ is a cycle of generalized Θ -graphs, we denote by Θ_i the i 'th generalized Θ -graph of Γ , that is, the subdivided copy of Ψ_{r_i} inside Γ , and we say that Θ_i is *non-trivial* if $r_i > 1$. Observe that the condition on the r_i guarantees that if Θ_i is trivial, then Θ_{i-1} and Θ_{i+1} are not, hence the vertices a_1, \dots, a_n have valence at least three in Γ . It follows that a cycle of generalized Θ -graphs Γ is 3-convex if and only if each edge of Ψ is subdivided into at least three edges, by inserting at least two vertices.

We now use this notation to define Euler characteristic vectors associated to cycles of generalized Θ -graphs.

Definition 1.11. [Euler characteristic vectors for cycles of generalized Θ -graphs] Let Γ be a 3-convex cycle of N generalized Θ -graphs and let $I \subset \{1, \dots, N\}$ be the set of indices with $r_i > 1$ (so I records the indices i for which Θ_i is non-trivial).

- (1) For each $i \in I$, we define the vector $v_i \in \mathbb{Q}^{r_i}$ to be the Euler characteristic vector of W_{Θ_i} (from Definition 1.7). Thus if Θ_i has branches $\beta_{i1}, \dots, \beta_{ir_i}$, with $r_i > 1$, then

$$v_i = (\chi(W_{\beta_{i1}}), \dots, \chi(W_{\beta_{ir_i}})) =: (\chi_{i1}, \dots, \chi_{ir_i}).$$

- (2) If there is some $r \geq 2$ so that each non-trivial Θ_i has exactly r branches, we define another vector w associated to Γ as follows. Let A be the union of $\{a_1, \dots, a_n\}$ with the vertex sets of all trivial Θ_i . Then $w \in \mathbb{Q}^{r+1}$ is the reordering of the vector

$$\left(\sum_{i \in I} \chi_{i1}, \sum_{i \in I} \chi_{i2}, \dots, \sum_{i \in I} \chi_{ir}, \chi(W_A) \right)$$

obtained by putting its entries in non-increasing order.

For example, the graph Γ' in Figure 1.1 has $I = \{1, 2, 3\}$, with say $v_1 = v_2 = (-\frac{1}{4}, -\frac{1}{2})$ and $v_3 = (-\frac{1}{4}, -\frac{1}{4}, -\frac{1}{2})$. If Γ'' is as in Figure 1.1, then $r = 2$, we can choose $I = \{1, 2, 3\}$, and then $v_1 = v_2 = (-\frac{1}{4}, -\frac{1}{2})$, $v_3 = (-\frac{3}{4}, -\frac{3}{2})$, $\chi(W_A) = -\frac{5}{4}$, and $w = (-\frac{5}{4}, -\frac{5}{4}, -\frac{5}{2})$.

We can now state the commensurability classification of right-angled Coxeter groups defined by 3-convex cycles of generalized Θ -graphs.

Theorem 1.12. *Let Γ and Γ' be 3-convex cycles of N and N' generalized Θ -graphs, respectively (with $N, N' \geq 3$). Let r_i be the number of branches of the i 'th generalized Θ -graph Θ_i in Γ , and let I be the set of indices with $r_i > 1$. Let $\{v_i \mid i \in I\}$ and w be the vectors from Definition 1.11, and let W_A be the special subgroup from Definition 1.11(2). Here, $\{v_i \mid i \in I\}$ denotes a multiset of vectors (since the v_i may not all be distinct). Let $r'_k, \Theta'_k, I', \{v'_k \mid k \in I'\}$, w' , and $W_{A'}$ be the corresponding objects for Γ' .*

The right-angled Coxeter groups $W = W_\Gamma$ and $W' = W_{\Gamma'}$ are abstractly commensurable if and only if at least one of (1) or (2) below holds.

- (1) (a) *The set of commensurability classes of the vectors $\{v_i \mid i \in I\}$ coincides with the set of commensurability classes of the vectors $\{v'_k \mid k \in I'\}$; and*
(b) *given a commensurability class of vectors \mathcal{V} , if $I_{\mathcal{V}} \subset I$ is the set of indices of the vectors in $\{v_i \mid i \in I\} \cap \mathcal{V}$, and $I'_{\mathcal{V}} \subset I'$ is the set of indices of the vectors in $\{v'_k \mid k \in I'\} \cap \mathcal{V}$, then*

$$\chi(W_{A'}) \cdot \left(\sum_{i \in I_{\mathcal{V}}} \chi(W_{\Theta_i}) \right) = \chi(W_A) \cdot \left(\sum_{k \in I'_{\mathcal{V}}} \chi(W_{\Theta'_k}) \right).$$

- (2) *There exists $r \geq 2$ such that each non-trivial generalized Θ -graph in Γ and in Γ' has r branches, and:*
(a) *the vectors v_i for $i \in I$ are contained in a single commensurability class; likewise, the vectors v'_k for $k \in I'$ are contained in a single commensurability class; and*
(b) *the vectors w and w' are commensurable.*

Remark 1.13. For a pair of graphs Γ and Γ' as in the statement of Theorem 1.12, with W_Γ and $W_{\Gamma'}$ abstractly commensurable, it is possible that (1) holds but not (2), that (2) holds but not (1), or that both (1) and (2) hold.

Remark 1.14. If Γ is a generalized Θ -graph as in the statement of Theorem 1.8, then the result of doubling Γ along a vertex of valence 2 which is adjacent to a vertex of valence at least 3 is a cycle of three generalized Θ -graphs, and by doubling again if necessary, we can obtain a 3-convex cycle of generalized Θ -graphs Γ' such that the groups W_Γ and $W_{\Gamma'}$ are commensurable (compare Remark 1.9). Hence we can determine which groups from Theorems 1.8 and 1.12 are commensurable to each other.

We then turn our attention to the relationship between right-angled Coxeter groups and geometric amalgams of free groups. We prove the following two theorems. Recall that \mathcal{G} is the class of graphs satisfying Assumptions 1.1 and 1.2.

Theorem 1.15. *If $\Gamma \in \mathcal{G}$ and Γ is 3-convex, then W_Γ has an index 16 subgroup which is a geometric amalgam of free groups.*

Theorem 1.16. *If a geometric amalgam of free groups has JSJ graph which is a tree, then it is abstractly commensurable to a right-angled Coxeter group (with defining graph in \mathcal{G}).*

In addition, we show that if the diameter of the JSJ graph of the geometric amalgam of free groups is at most 4, then the defining graph of the corresponding right-angled Coxeter group guaranteed by Theorem 1.16 is either a generalized Θ -graph or a cycle of generalized Θ -graphs. Thus we have the following corollary.

Corollary 1.17. *Geometric amalgams of free groups whose JSJ graphs are trees of diameter at most 4 can be classified up to abstract commensurability.*

Acknowledgements. We thank the Forschungsinstitut für Mathematik at ETH Zürich, for hosting Thomas in Spring Semester 2016 and supporting a visit by Dani in June 2016, during which part of this research was carried out. This research was also supported by the National Science Foundation under Grant No. DMS-1440140 while the Dani and Thomas were in residence at the Mathematical Sciences Research Institute (MSRI) in Berkeley, California during the Fall 2016 semester. We also thank MSRI for supporting a visit by Stark in Fall 2016. Dani was partially supported by NSF Grant No. DMS-1207868 and this work was supported by a grant from the Simons Foundation (#426932, Pallavi Dani). Thomas was partially supported by an Australian Postdoctoral Fellowship and this research was supported in part by Australian Research Council Grant No. DP110100440.

2. PRELIMINARIES

We recall relevant graph theory in Section 2.1. Section 2.2 states the results on JSJ decompositions from [7] that we will need, and establishes some technical lemmas. In Section 2.3 we recall from [16] the definitions of geometric amalgams of free groups and surface amalgams, and state Lafont's topological rigidity result. Finally, Section 2.4 contains some well-known results on coverings of surfaces with boundary.

2.1. Graph theory. In this paper, we work with several different kinds of graphs. We now recall some graph-theoretic terminology and establish notation.

We will mostly consider unoriented graphs, and so refer to these as just *graphs*. As in [1], a *graph* Λ consists of a vertex set $V(\Lambda)$, an edge set $E(\Lambda)$, and a map $\epsilon : E(\Lambda) \rightarrow V(\Lambda)^2/C_2$ from the edge set to the set of unordered pairs of elements of $V(\Lambda)$. For an edge e , we write $\epsilon(e) = [x, y] = [y, x]$, where $x, y \in V(\Lambda)$. An edge e is a *loop* if $\epsilon(e) = [x, x]$ for some $x \in V(\Lambda)$. If $\epsilon(e) = [x, y]$ we say that e is *incident* to x and y , and when $x \neq y$, that x and y are *adjacent* vertices. The *valence* of a vertex x is the number of edges incident to x , counting 2 for each loop e with $\epsilon(e) = [x, x]$. A vertex is *essential* if it has valence at least 3.

Identifying Λ with its realization as a 1-dimensional cell complex, a *cut pair* in Λ is a pair of vertices $\{x, y\}$ so that $\Lambda \setminus \{x, y\}$ has at least two components, where a *component* by definition contains at least one vertex. An cut pair $\{x, y\}$ is *essential* if x and y are both essential vertices. A *reduced path* in Λ is a path which does not self-intersect. A *branch* of Λ is a subgraph of Λ consisting of a (closed) reduced path between a pair of essential vertices, which does not contain any essential vertices in its interior.

A graph Λ is *bipartite* if $V(\Lambda)$ is the disjoint union of two nonempty subsets $V_1(\Lambda)$ and $V_2(\Lambda)$, such that every edge of Λ is incident to exactly one element of $V_1(\Lambda)$ and exactly one element of $V_2(\Lambda)$. In this case, we sometimes refer to the vertices in $V_1(\Lambda)$ as the *Type 1* vertices and those in $V_2(\Lambda)$ as the *Type 2* vertices.

An *oriented graph* Λ consists of a vertex set $V(\Lambda)$, an edge set $E(\Lambda)$, and maps $i : E(\Lambda) \rightarrow V(\Lambda)$ and $t : E(\Lambda) \rightarrow V(\Lambda)$. For each edge $e \in E(\Lambda)$, we refer to $i(e)$ as the *initial vertex* of e and $t(e)$ as the *terminal vertex* of e . Other definitions are similar to the unoriented case.

Throughout this paper, we reserve the notation Γ and Γ' for defining graphs of right-angled Coxeter groups, and we assume throughout that Γ and Γ' are finite, simplicial graphs in \mathcal{G} , that is, they satisfy Assumptions 1.1 and 1.2. (A graph Γ is *simplicial* if it has no loops and the map ϵ is injective, that is, Γ does not have any multiple edges.)

2.2. JSJ decomposition of right-angled Coxeter groups. In this section we recall the results we will need from [7]. We also establish some technical lemmas needed for our constructions in Section 3, which use similar arguments to those in [7].

2.2.1. JSJ decomposition. Let $W = W_\Gamma$. The main result of [7] gives an explicit description of the W -orbits in Bowditch's JSJ tree $\mathcal{T} = \mathcal{T}_{W_\Gamma}$ and the stabilizers for this action. From this, we can obtain an explicit description of the canonical graph of groups induced by the action of W on \mathcal{T} . Recall from the introduction that the quotient graph $\Lambda = W \backslash \mathcal{T}$ is the *JSJ graph of W* and the canonical graph of groups over Λ is the *JSJ decomposition of W* . The JSJ graph Λ is in fact a tree, since W is not an HNN extension (like any Coxeter group, W is generated by torsion elements hence does not surject to \mathbb{Z}). The next result follows from Theorem 3.36 of [7], and is illustrated by the examples in Figure 2.1.

Corollary 2.1. *Let Γ be a finite, simplicial graph satisfying Assumptions 1.1 and 1.2, so that Γ is 3-convex. The JSJ decomposition for $W = W_\Gamma$ is as follows:*

- (1) *For each pair of essential vertices $\{a, b\}$ of Γ such that $\Gamma \setminus \{a, b\}$ has $k \geq 3$ components, the JSJ graph Λ has a vertex of valence k , with local group $\langle a, b \rangle$.*
- (2) *For each set A of vertices of Γ satisfying the following conditions:*
 - (α_1) *elements of A pairwise separate $|\Gamma|$, the geometric realization of Γ ;*
 - (α_2) *the set A is maximal among all sets satisfying (α_1); and*
 - (α_3) *$\langle A \rangle$ is infinite but not 2-ended;**the JSJ graph Λ has a vertex of valence ℓ where $\ell \geq 1$ is the number of distinct pairs of essential vertices in A which are as in (1). The local group at this vertex is $\langle A \rangle$.*
- (3) *A vertex v_1 as in (1) and a vertex v_2 as in (2) are adjacent if and only if their local groups intersect, with this intersection necessarily $\langle a, b \rangle$ where $\{a, b\}$ are as in (1). There will then be an edge with local group $\langle a, b \rangle$ between these vertices. All maps from edge groups to vertex groups are inclusions.*

For $i = 1, 2$, we refer to the vertices of the JSJ graph Λ as in part (i) of Corollary 2.1 as the *Type i vertices*, and denote these by $V_i(\Lambda)$. The JSJ graph Λ is a bipartite graph, with vertex set $V(\Lambda) = V_1(\Lambda) \sqcup V_2(\Lambda)$.

2.2.2. Technical lemmas. We will use in Section 3 the following technical lemmas related to the JSJ decomposition, where Γ is as in the statement of Corollary 2.1.

Lemma 2.2. *Suppose a Type 2 vertex in the JSJ decomposition of W_Γ has stabilizer $\langle A \rangle$. Let $L = L_A$ be the number of essential vertices in A . Then $L \geq 2$, and $L = 2$ if and only if A is equal to the set of vertices of a branch of Γ (including its end vertices).*

Proof. The fact that $L \geq 2$ follows from the vertex v having valence $\ell \geq 1$, and the description given in Corollary 2.1 of the vertices adjacent to v .

If A equals the set of vertices of a branch of Γ , then it is clear that $L = 2$. Conversely, if $L = 2$ let the two essential vertices of A be a and b . Since $\langle A \rangle$ is not 2-ended by (α_3), the set A must also contain a non-essential vertex, say a' . Let β be the branch of Γ containing a' . Using Lemma 3.20

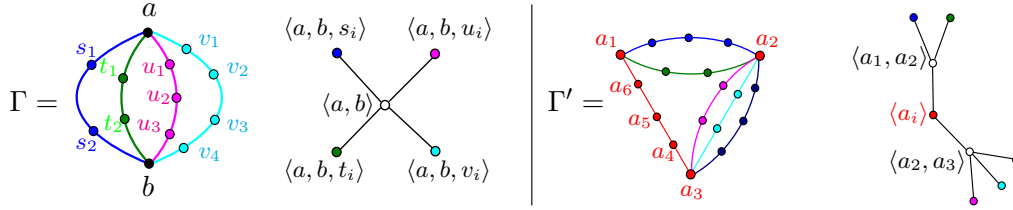

FIGURE 2.1. Examples of JSJ decompositions given by Corollary 2.1. From left to right, we have a defining graph Γ , the JSJ decomposition of W_Γ , a defining graph Γ' , and the JSJ decomposition of $W_{\Gamma'}$. In the JSJ decompositions, the Type 1 vertices are white, all unlabelled Type 2 vertex groups are the special subgroups corresponding to the branches indicated by color, and all edge groups are equal to the groups on the adjacent Type 1 vertices.

of [7], we obtain that A contains all vertices of β , including its end vertices. Since $L = 2$, these end vertices must be a and b . If A contains a vertex c of Γ which is not in the branch β , then since $L = 2$, the vertex c must be non-essential and lie on another branch, say β' , between a and b . Now the graph Γ is not a cycle, so the pair $\{a', c\}$ cannot separate $|\Gamma|$. This contradicts (α_1) . So if $L = 2$, the set A is equal to the set of vertices of a branch β in Γ . \square

Lemma 2.3. *Suppose a Type 2 vertex in the JSJ decomposition of W_Γ has stabilizer $\langle A \rangle$. Assume A contains the set of vertices of a branch β of Γ , including its end vertices b and b' . Let k be the number of components of $\Gamma \setminus \{b, b'\}$. Then $k \geq 2$, and $k \geq 3$ if and only if A equals the set of vertices of β .*

Proof. First observe that $k \geq 2$ since Γ is 3-convex. Now assume $k \geq 3$. If A contains a vertex a which is not on β , and b is an interior vertex of β , then since $k \geq 3$ the pair $\{a, b\}$ cannot separate $|\Gamma|$. This contradicts condition (α_1) for A . Thus if $k \geq 3$, the set A equals the vertex set of β .

Now suppose that A equals the vertex set of β , and let ℓ be valence of the vertex of the JSJ graph which has stabilizer $\langle A \rangle$. Then by (2) of Corollary 2.1, we have that $\ell \geq 1$ and that A must contain at least one pair of vertices as in (1) of Corollary 2.1. Since A equals the vertex set of the branch β , the set A contains at most one pair of vertices as in (1) of Corollary 2.1, namely the pair $\{b, b'\}$. By the description given in (1) of Corollary 2.1, it follows that $k = 3$. \square

Lemma 2.4. *Suppose a Type 2 vertex in the JSJ decomposition of W_Γ has stabilizer $\langle A \rangle$.*

- (1) *The set A has a well-defined cyclic ordering a_1, \dots, a_n .*
- (2) *Assume A contains $L \geq 3$ essential vertices, and let a_{i_1}, \dots, a_{i_L} be the essential vertices of A in the cyclic ordering. For $1 \leq j \leq L$ let k_j be the number of components of $\Gamma \setminus \{a_{i_j}, a_{i_{j+1}}\}$.*
 - (a) *For all $1 \leq j \leq L$, $k_j \geq 2$, hence $\{a_{i_j}, a_{i_{j+1}}\}$ is an essential cut pair.*
 - (b) *For each $1 \leq j \leq L$, there is at least one branch β of Γ between a_{i_j} and $a_{i_{j+1}}$.*
 - (c) *Suppose $a \in A$ is a non-essential vertex, lying between a_{i_j} and $a_{i_{j+1}}$ in the cyclic ordering. Then $k_j = 2$, there is a unique branch $\beta = \beta_j$ of Γ between a_{i_j} and $a_{i_{j+1}}$, all vertices of β are contained in A , and β contains the vertex a .*
 - (d) *If there are no non-essential vertices of A lying between a_{i_j} and $a_{i_{j+1}}$ in the cyclic ordering on A , then $k_j \geq 3$.*
 - (e) *Suppose $a, b \in A$ are such that $\langle a, b \rangle$ is the stabilizer of a Type 1 vertex in the JSJ decomposition of W_Γ . Then a and b are adjacent in the cyclic ordering on A .*

Proof. Part (1) is Lemma 3.14(1) of [7].

For (2)(a), we have $k_j \geq 2$ for all j by (α_1) in Corollary 2.1 and the graph Γ being 3-convex.

For (2)(b), let σ be an induced cycle in Γ containing all vertices of A , as guaranteed by Lemma 3.12 of [7]. Then since a_{i_j} and $a_{i_{j+1}}$ are adjacent essential vertices in the cyclic ordering on A , there is an arc of $\sigma \setminus \{a_{i_j}, a_{i_{j+1}}\}$ which contains no essential vertices of A . To see that there is a branch β between a_{i_j} and $a_{i_{j+1}}$, it suffices to show that this arc contains no essential vertices of Γ . Assume there is an essential vertex b of Γ which lies on σ between a_{i_j} and $a_{i_{j+1}}$. Then it is not hard to see that either every reduced path from a_{i_j} to $a_{i_{j+1}}$ in the component of $\Gamma \setminus \{a_{i_j}, a_{i_{j+1}}\}$ containing b passes through b , or Γ contains a subdivided K_4 subgraph. In the first case, by the maximality condition (α_2) of Corollary 2.1, the vertex b is in A , which is a contradiction. The second case contradicts Assumption 1.2. Hence there is at least one branch β of Γ between a_{i_j} and $a_{i_{j+1}}$.

To prove (2)(c), let a be a non-essential vertex of A lying between a_{i_j} and $a_{i_{j+1}}$ in the cyclic ordering, and let β be the branch of Γ containing a . Then all vertices of β are in A , by Lemma 3.20 of [7]. Since the cyclic ordering on A is well-defined, and β contains a , it follows that the branch β has endpoints a_{i_j} and $a_{i_{j+1}}$. Now as $L \geq 3$, the set A is not equal to the vertex set of β . Thus by Lemma 2.3 we get that $k_j = 2$. So there is at most one branch of Γ between a_{i_j} and $a_{i_{j+1}}$. Hence $\beta = \beta_j$ is the unique branch of Γ between a_{i_j} and $a_{i_{j+1}}$. We have proved all claims in (2)(c).

For (2)(d), since there are no non-essential vertices of A lying between a_{i_j} and $a_{i_{j+1}}$ in the cyclic ordering on A , without loss of generality $a_{i_j} = a_1$ and $a_{i_{j+1}} = a_2$, and $\Gamma \setminus \{a_1, a_2\}$ has $k_j = k \geq 2$ components. By (2)(b), there is a branch β of Γ between a_1 and a_2 . Assume $k = 2$. We will obtain a contradiction by showing that every interior vertex of β is in A . Let b be an interior vertex of β . First notice that the pairs $\{a_1, b\}$ and $\{a_2, b\}$ both separate $|\Gamma|$, and that if b' is any other interior vertex of β then $\{b, b'\}$ also separates $|\Gamma|$. Now since $k = 2$, for every $a \in A$ which is not in β , the pair $\{a, b\}$ separates $|\Gamma|$ if and only if both $\{a, a_1\}$ and $\{a, a_2\}$ separates $|\Gamma|$. There is at least one such a since $L \geq 3$. It follows that for all $a \in A$ and for all vertices b in the interior of β , the pair $\{a, b\}$ separates $|\Gamma|$. Hence by the maximality condition (α_2) , every interior vertex of β is in A . This contradicts a_1 and a_2 being adjacent in the cyclic ordering on A , so $k_j \geq 3$ as required.

To prove (2)(d), we have by Corollary 2.1 that $\Gamma \setminus \{a, b\}$ has $k \geq 3$ components. Let σ be an induced cycle in Γ containing all vertices of A , as guaranteed by Lemma 3.12 of [7], and suppose a and b are not consecutive in the cyclic ordering on A . Then there are vertices $c, d \in A$ so that one of the arcs of σ from a to b contains c and the other arc contains d . Since $k \geq 3$, there is also a reduced path from a to b which misses both c and d . But this contradicts Lemma 3.14(2) of [7]. Hence a and b are consecutive in the cyclic ordering on A , as required. \square

Lemma 2.5. *If a Type 2 vertex in the JSJ decomposition of W_Γ has stabilizer $\langle A \rangle$, then the set A is not equal to the vertex set of an induced cycle in Γ .*

Proof. If A is equal to the vertex set of an induced cycle in Γ , then the group $\langle A \rangle$ is cocompact Fuchsian, which contradicts the characterization of stabilizers of Type 2 vertices in [3]. \square

Remark 2.6. Suppose Λ is the JSJ graph of a right-angled Coxeter group W_Γ as in the statement of Corollary 2.1. Then Λ is a finite tree (containing at least one edge). By Corollary 2.1(1), all Type 1 vertices of Λ have valence ≥ 3 . Hence all valence one vertices of Λ are of Type 2, so Λ has even diameter. Using Corollary 2.1 and the above technical lemmas, it is not hard to check that Λ has diameter 2 if and only if Γ is a generalized Θ -graph, and that Λ has diameter 4 if and only if Γ is a cycle of generalized Θ -graphs (with Γ being 3-convex and satisfying Assumptions 1.1 and 1.2 in both cases).

2.3. Surface amalgams and topological rigidity. We now recall some definitions and a topological rigidity result from Lafont [16].

Definition 2.7 (Surface amalgams and geometric amalgams of free groups). Consider a graph of spaces over an oriented graph Λ with the following properties.

- (1) The underlying graph Λ is bipartite with vertex set $V(\Lambda) = V_1 \sqcup V_2$, such that each edge e of Λ has $i(e) \in V_1$ and $t(e) \in V_2$.
- (2) The vertex space C_x associated to a vertex $x \in V_1$ is a copy of the circle S^1 . The vertex space S_y associated to a vertex $y \in V_2$ is a connected surface with negative Euler characteristic and non-trivial boundary.
- (3) Given an edge e of Λ , the edge space B_e is a copy of S^1 . The map $\phi_{e,i(e)} : B_e \rightarrow C_{i(e)}$ is a homeomorphism, and the map $\phi_{e,t(e)} : B_e \rightarrow S_{t(e)}$ is a homeomorphism onto a boundary component of $S_{t(e)}$.
- (4) Each vertex $x \in V_1$ has valence at least 3. Given any vertex $y \in V_2$, for each boundary component B of S_y , there exists an edge e with $t(e) = y$, such that the associated edge map identifies B_e with B . The valence of y is the number of boundary components of S_y .

A *surface amalgam* $\mathcal{X} = \mathcal{X}(\Lambda)$ is the image of the above graph of spaces under the homotopy equivalence which collapses $B_e \times I$ to a single circle for each edge e . If \mathcal{X} is a surface amalgam, the *surfaces in \mathcal{X}* are the surfaces S_y for $y \in V_2(\Lambda)$. The fundamental group of a surface amalgam is a *geometric amalgam of free groups*.

Note that in [16], surface amalgams are called *simple, thick, 2-dimensional hyperbolic P-manifolds*.

For an oriented graph Λ as in Definition 2.7, we may by abuse of notation write Λ for the unoriented graph with the same vertex and edge sets and $\epsilon : E(\Lambda) \rightarrow V(\Lambda)/C_2$ given by $\epsilon(e) = [i(e), t(e)]$. We note that:

Remark 2.8. If $\mathcal{X} = \mathcal{X}(\Lambda)$ is a surface amalgam, then the JSJ graph of the geometric amalgam of free groups $\pi_1(\mathcal{X})$ is the (unoriented) graph Λ . For details, see [18, Section 4.1].

We will use the following topological rigidity result of Lafont.

Theorem 2.9. [16, Theorem 1.2] *Let \mathcal{X} and \mathcal{X}' be surface amalgams. Then any isomorphism $\phi : \pi_1(\mathcal{X}) \rightarrow \pi_1(\mathcal{X}')$ is induced by a homeomorphism $f : \mathcal{X} \rightarrow \mathcal{X}'$.*

2.4. Coverings of surfaces. We now recall some results on coverings of surfaces.

We write $S_{g,b}$ for the connected, oriented surface of genus g with b boundary components. This surface has Euler characteristic $\chi(S_{g,b}) = 2 - 2g - b$. The next lemma allows us to obtain positive genus covers of any $S_{g,b}$ with negative Euler characteristic.

Lemma 2.10. *Suppose $\chi(S_{g,b}) < 0$. Then $S_{g,b}$ has a connected 3-fold covering $S_{g',b}$, where $g' = 3g + b - 2$ and so $g' > 0$.*

Proof. By Proposition 5.2 of Edmonds, Kulkarni, and Stong [9], it is enough to check that $\chi(S_{g',b}) = 3\chi(S_{g,b})$. This is an easy calculation. \square

We have the following easy corollary.

Corollary 2.11. *If $\mathcal{X} = \mathcal{X}(\Lambda)$ is a surface amalgam, then \mathcal{X} has an degree 3 cover \mathcal{X}' which is a surface amalgam whose underlying graph is also Λ , so that each surface in \mathcal{X}' has positive genus.* \square

We will make repeated use of the following lemma concerning coverings of positive genus surfaces with boundary, from Neumann [19]. As discussed in [19], the result appears to be well-known.

Lemma 2.12. [19, Lemma 3.2] *Let $S = S_{g,b}$ where $g > 0$ and $b > 0$. Let D be a positive integer. Suppose that for each boundary component of S , a collection of degrees summing to D is specified. Then S has a connected D -fold covering S' with $b' \geq b$ boundary components and these specified degrees on the collection of boundary components of S' lying over each boundary component of S if and only if b' has the same parity as $D \cdot \chi(S)$.*

3. ORBICOMPLEX CONSTRUCTION

From now on, Γ is a finite, simplicial, 3-convex graph satisfying Assumptions 1.1 and 1.2. In this section we construct a piecewise-hyperbolic orbicomplex \mathcal{O}_Γ with fundamental group W_Γ , such that covers of \mathcal{O}_Γ corresponding to torsion-free, finite-index subgroups of W_Γ are surface amalgams. The bottom right of Figure 4.3 gives an example of the orbicomplex \mathcal{O}_Γ when Γ is a generalized Θ -graph, and Figure 4.4 contains an example of \mathcal{O}_Γ when Γ is a cycle of generalized Θ -graphs. We begin by constructing hyperbolic orbifolds in Sections 3.1 and 3.2 which have fundamental groups the stabilizers of Type 2 vertices in the JSJ decomposition of W_Γ (see Corollary 2.1). The underlying spaces of these orbifolds are right-angled hyperbolic polygons. We then in Section 3.3 glue these orbifolds together along their non-reflection edges to obtain \mathcal{O}_Γ .

3.1. Branch orbifolds. For each branch β in Γ , we construct an orbifold \mathcal{P}_β with fundamental group the special subgroup W_β . We call \mathcal{P}_β a *branch orbifold*. We will also assign types to some of the edges and vertices of \mathcal{P}_β , which will later be used to glue \mathcal{P}_β to other orbifolds.

Let β be a branch with $n = n_\beta$ vertices (including its endpoints). Since Γ is 3-convex, we have $n \geq 4$. Let $P = P_\beta$ be a right-angled hyperbolic p -gon where $p = n + 1 \geq 5$. We construct P to have one edge of length 1.

Now we construct the orbifold \mathcal{P}_β over P . The distinguished edge of P with length 1 is a non-reflection edge of \mathcal{P}_β . The other $n = p - 1$ edges of P are reflection edges of \mathcal{P}_β , with local groups $\langle b_1 \rangle, \dots, \langle b_n \rangle$ in that order, where b_1, \dots, b_n are the vertices in β going in order along the branch. For the vertex groups of \mathcal{P}_β , the endpoints of the unique non-reflection edge of \mathcal{P}_β have groups $\langle b_1 \rangle$ and $\langle b_n \rangle$, so that for $i = 1$ and $i = n$ the vertex group $\langle b_i \rangle$ is adjacent to the edge group $\langle b_i \rangle$. The other $n - 1 = p - 2$ vertex groups of \mathcal{P}_β are $\langle b_i, b_{i+1} \rangle \cong C_2 \times C_2$ for $1 \leq i < n$, with $\langle b_i, b_{i+1} \rangle$ the local group at the vertex of \mathcal{P}_β whose adjacent edges have local groups $\langle b_i \rangle$ and $\langle b_{i+1} \rangle$.

Lemma 3.1. *The fundamental group of \mathcal{P}_β is W_β .*

Proof. We regard \mathcal{P}_β as a simple polygon of groups over the underlying polygon P , with trivial face group, trivial group on the non-reflection edge, and the other edge and vertex groups as described above (see [4, Example 12.17(6)] for the general definition of a simple polygon of groups). Notice that each vertex group is generated by its adjacent edge groups. Since the face group is trivial, it follows that the fundamental group of \mathcal{P}_β is generated by its edge groups, subject to the relations imposed within its vertex groups (compare [4, Definition 12.12]). Hence by construction, $\pi_1(\mathcal{P}_\beta)$ is generated by the vertices of the branch β , which are b_1, \dots, b_n going in order along the branch, with relations $b_i^2 = 1$ for $1 \leq i \leq n$, and $[b_i, b_{i+1}] = 1$ for $1 \leq i < n$. That is, $\pi_1(\mathcal{P}_\beta)$ is the special subgroup W_β generated by the vertex set of β . \square

We assign the non-reflection edge of \mathcal{P}_β to have type $\{b_1, b_n\}$. Note that since b_1 and b_n are the end vertices of a branch in Γ , the pair $\{b_1, b_n\}$ is an essential cut pair in Γ . For $i = 1$ and $i = n$, we assign type $\{b_i\}$ to the vertex of \mathcal{P}_β which has group $\langle b_i \rangle$.

3.2. Essential vertex orbifolds and non-branch orbifolds. Now let A be a subset of vertices of Γ so that $W_A = \langle A \rangle$ is the stabilizer of a Type 2 vertex in the JSJ decomposition, and let L be the number of essential vertices of A . Recall from Lemma 2.2 that $L \geq 2$. In this section, we assume that $L \geq 3$ and construct two hyperbolic orbifolds, \mathcal{Q}_A and \mathcal{A} .

By Lemma 2.2, since $L \geq 3$ the set A is not equal to the set of vertices of a branch of Γ . However A may still contain the vertex sets of branches. The orbifold \mathcal{A} will be constructed in two stages: we first construct the orbifold \mathcal{Q}_A over a $2L$ -gon, and then obtain \mathcal{A} by gluing on the branch orbifold \mathcal{P}_β for each branch β whose vertex set is contained in A . The fundamental group of \mathcal{Q}_A will be the special subgroup generated by the essential vertices in A , and \mathcal{A} will have fundamental group W_A . We refer to \mathcal{Q}_A as an *essential vertex orbifold* and to \mathcal{A} as a *non-branch orbifold*.

We now construct \mathcal{Q}_A . Let $Q = Q_A$ be a right-angled hyperbolic $2L$ -gon ($L \geq 3$). Using the following lemma, we can specify that alternate edges of Q have length 1.

Lemma 3.2. *Given $L \geq 3$, there exists a right-angled hyperbolic $2L$ -gon in which alternate edges have length 1.*

Proof. Given any three positive numbers, there exists a right-angled hyperbolic hexagon with alternate edges having lengths equal to these three numbers (cf. Proposition B.4.13 of [2].) The result then follows by induction on L , since if a right-angled hyperbolic hexagon with alternate edges of length 1 is glued along an edge of length 1 to a right-angled hyperbolic $2L$ -gon with alternate edges of length 1, the result is a right-angled hyperbolic $2(L+1)$ -gon with alternate edges of length 1. \square

The essential vertex orbifold \mathcal{Q}_A is constructed over Q . The alternate edges of Q of length 1 will be non-reflection edges of \mathcal{Q}_A . The remaining edges of \mathcal{Q}_A will be reflection edges, as follows. By Lemma 2.4(1), the set A has a well-defined cyclic ordering a_1, \dots, a_n . Let a_{i_1}, \dots, a_{i_L} be the essential vertices of A in this induced cyclic order. The reflection edges of \mathcal{Q}_A will have groups $\langle a_{i_j} \rangle \cong C_2$ for $1 \leq j \leq L$, going in order around Q . Now each vertex of \mathcal{Q}_A is adjacent to one non-reflection edge and one reflection edge with group $\langle a_{i_j} \rangle$, and this vertex will also have group $\langle a_{i_j} \rangle$.

We next assign types to certain edges and all vertices of \mathcal{Q}_A . The non-reflection edges going around \mathcal{Q}_A are assigned type $\{a_{i_j}, a_{i_{j+1}}\}$ (where $j \in \mathbb{Z}/L\mathbb{Z}$), and we assign type $\{a_{i_j}\}$ to the vertices of \mathcal{Q}_A with group $\langle a_{i_j} \rangle$, so that the endpoints of the non-reflection edge of \mathcal{Q}_A with type $\{a_{i_j}, a_{i_{j+1}}\}$ have types $\{a_{i_j}\}$ and $\{a_{i_{j+1}}\}$. Notice that each pair $\{a_{i_j}, a_{i_{j+1}}\}$ is an essential cut pair, by Lemma 2.4(2)(a).

We now construct the non-branch orbifold \mathcal{A} . If A consists entirely of essential vertices, then we put $\mathcal{A} = \mathcal{Q}_A$. Otherwise, by Lemma 2.4(2)(c), there is at least one pair $\{a_{i_j}, a_{i_{j+1}}\}$ of essential vertices in A so that $\Gamma \setminus \{a_{i_j}, a_{i_{j+1}}\}$ has $k_j = 2$ components, and for all such j , there is a unique branch β_j of Γ between a_{i_j} and $a_{i_{j+1}}$. Denote by P_j the right-angled polygon underlying the branch orbifold \mathcal{P}_{β_j} constructed in Section 3.1 above. Recall that all non-reflection edges in \mathcal{Q}_A have length 1, and that the unique non-reflection edge in \mathcal{P}_{β_j} has length 1 as well. Also, the non-reflection edge of \mathcal{P}_{β_j} has type $\{a_{i_j}, a_{i_{j+1}}\}$.

To obtain \mathcal{A} , for each j such that A contains the vertex set of β_j , we glue the non-reflection edge of \mathcal{Q}_A of type $\{a_{i_j}, a_{i_{j+1}}\}$ to the non-reflection edge of \mathcal{P}_{β_j} , so that the types of the end-vertices match up. In both \mathcal{Q}_A and \mathcal{P}_{β_j} , the end-vertices of the edge which has just been glued have groups $\langle a_{i_j} \rangle$ and $\langle a_{i_{j+1}} \rangle$. Also, the edge groups adjacent to the vertex group $\langle a_{i_j} \rangle$ (respectively, $\langle a_{i_{j+1}} \rangle$) are both $\langle a_{i_j} \rangle$ (respectively, $\langle a_{i_{j+1}} \rangle$). So we may erase all of the non-reflection edges along which we just glued branch orbifolds to \mathcal{Q}_A , and combine the edges of \mathcal{Q}_A and \mathcal{P}_{β_j} with group $\langle a_{i_j} \rangle$ (respectively, $\langle a_{i_{j+1}} \rangle$) into a single edge with group $\langle a_{i_j} \rangle$ (respectively, $\langle a_{i_{j+1}} \rangle$). We now define \mathcal{A}

to be the resulting orbifold over the right-angled hyperbolic polygon obtained by gluing together the polygon Q_A which underlies \mathcal{Q}_A and the polygons P_j which underly the \mathcal{P}_{β_j} .

Lemma 3.3. *The fundamental group of \mathcal{A} is W_A .*

Proof. By construction, the reflection edges of \mathcal{A} have groups $\langle a_1 \rangle, \dots, \langle a_n \rangle$, where a_1, \dots, a_n is the cyclic ordering on A given by Lemma 2.4(1), and the reflection edges with groups $\langle a_i \rangle$ and $\langle a_{i+1} \rangle$ are adjacent in \mathcal{A} if and only if a_i and a_{i+1} are adjacent in Γ (for $i \in \mathbb{Z}/n\mathbb{Z}$). The proof then uses similar arguments to Lemma 3.1. \square

Observe that since A is not the vertex set of an induced cycle in Γ (by Lemma 2.5), it follows from our construction that \mathcal{A} has at least one non-reflection edge. The non-reflection edges of \mathcal{A} retain their types $\{a_{i_j}, a_{i_{j+1}}\}$ from \mathcal{Q}_A , as do the endpoints of such edges.

3.3. Construction of orbicomplex. We now construct the orbicomplex \mathcal{O}_Γ by gluing together certain branch orbifolds \mathcal{P}_β from Section 3.1 and all of the non-branch orbifolds \mathcal{A} from Section 3.2.

Consider a Type 2 vertex in the JSJ decomposition with stabilizer $\langle A \rangle$, where A is a set of vertices of Γ . Let L be the number of essential vertices of A . Then by Lemma 2.2, we have that $L \geq 2$, and $L = 2$ exactly when A is the set of vertices of a branch β of Γ . So if $L = 2$ then $W_A = W_\beta$ is the fundamental group of the branch orbifold \mathcal{P}_β , and if $L \geq 3$ then W_A is the fundamental group of the non-branch orbifold \mathcal{A} .

Let \mathcal{C} be the collection of all branch orbifolds \mathcal{P}_β such that $W_\beta = \pi_1(\mathcal{P}_\beta)$ is a Type 2 vertex stabilizer, together with all non-branch orbifolds \mathcal{A} . By the discussion in the previous paragraph, we have:

Corollary 3.4. *The set of orbifolds \mathcal{C} is in bijection with the set of Type 2 vertices in the JSJ decomposition of W_Γ . Moreover, for each orbifold \mathcal{O} in the collection \mathcal{C} , we have that $\pi_1(\mathcal{O})$ is equal to the stabilizer of the corresponding Type 2 vertex.*

We now consider the relationship between Type 1 vertices in the JSJ decomposition and non-reflection edges of orbifolds in the collection \mathcal{C} . Recall that each \mathcal{P}_β has a unique non-reflection edge, each \mathcal{A} has at least one non-reflection edge, and each non-reflection edge in either a \mathcal{P}_β or an \mathcal{A} has type $\{a, b\}$ where $\{a, b\}$ is an essential cut pair of Γ .

Lemma 3.5. *Each non-reflection edge in the collection of orbifolds \mathcal{C} has type $\{a, b\}$ where $\langle a, b \rangle$ is the stabilizer of a Type 1 vertex in the JSJ decomposition of W_Γ .*

Proof. First suppose that \mathcal{P}_β is in \mathcal{C} , let the endpoints of the branch β be b and b' , and let A be the vertex set of the branch β . Then since $W_\beta = W_A$ is the stabilizer of a Type 2 vertex, Lemma 2.3 implies that $\Gamma \setminus \{b, b'\}$ has $k \geq 3$ components. The result then follows from Corollary 2.1(1).

Now let \mathcal{A} be a non-branch orbifold and let $\{a_{i_j}, a_{i_{j+1}}\}$ be the type of a non-reflection edge of \mathcal{A} . Then by construction of \mathcal{A} and Lemma 2.4(d), we have that $\Gamma \setminus \{a_{i_j}, a_{i_{j+1}}\}$ has $k_j \geq 3$ components (otherwise, we would have glued a branch orbifold on at this edge of \mathcal{Q}_A). The result then also follows from Corollary 2.1(1). \square

Lemma 3.6. *Let a and b be vertices of Γ so that $\langle a, b \rangle$ is the stabilizer of a Type 1 vertex v of valence $k \geq 3$ in the JSJ decomposition of W_Γ . Then $\{a, b\}$ is the type of a non-reflection edge in exactly k orbifolds in the collection \mathcal{C} .*

Proof. Since v has valence k , by the first statement in Corollary 3.4 there are exactly k orbifolds in the collection \mathcal{C} whose fundamental groups are stabilizers of Type 2 vertices adjacent to v . By Corollary 2.1(3) and the second statement in Corollary 3.4, these k orbifolds are exactly the

elements of \mathcal{C} whose fundamental groups contain the generators a and b . If a branch orbifold \mathcal{P}_β is one of these k orbifolds, then a and b are the endpoints of the branch β , so by construction the unique non-reflection edge of \mathcal{P}_β is of type $\{a, b\}$. If a non-branch orbifold \mathcal{A} is one of these k orbifolds, let A be the set of vertices of Γ so that $W_A = \pi_1(\mathcal{A})$. By the construction of \mathcal{A} , it suffices to show that a and b are consecutive in the cyclic ordering on A given by Lemma 2.4(1), and this is Lemma 2.4(2)(e). \square

Recall that each non-reflection edge in the orbifolds we have constructed has length 1. Now for each $\{a, b\}$ which is the type of some non-reflection edges in the collection \mathcal{C} , we glue together all non-reflection edges of type $\{a, b\}$ in this collection, so that the types of their end-vertices are preserved. The resulting orbicomplex is \mathcal{O}_Γ .

Note that in the resulting space, each non-reflection edge still has a well-defined type $\{a, b\}$, and is the unique non-reflection edge of this type. Also, if a non-reflection edge e of \mathcal{O}_Γ has type $\{a, b\}$, and v is its vertex of type $\{a\}$ (respectively, $\{b\}$), then the vertex group of \mathcal{O}_Γ at v is $\langle a \rangle$ (respectively, $\langle b \rangle$), and each reflection edge of \mathcal{O}_Γ which is adjacent to v has group $\langle a \rangle$ (respectively, $\langle b \rangle$).

Lemma 3.7. *The orbicomplex \mathcal{O}_Γ has fundamental group W_Γ .*

Proof. The underlying space of \mathcal{O}_Γ is obtained by gluing together the polygons underlying the orbifolds in the collection \mathcal{C} along non-reflection edges. After gluing, there is a polygon in the resulting space for each Type 2 vertex in the JSJ decomposition, and a single non-reflection edge contained in at least 3 distinct polygons for each Type 1 vertex in the JSJ decomposition. Since the JSJ decomposition is over a connected graph, it follows that the underlying space after gluing is connected. Moreover, since the JSJ decomposition is over a tree, it follows that the underlying space after gluing is contractible. Hence the fundamental group of \mathcal{O}_Γ is generated by the fundamental groups of the orbifolds in \mathcal{C} , subject to the identifications of generators induced by gluing non-reflection edges. This gives fundamental group W_Γ . \square

4. HALF-COVERINGS AND TORSION-FREE COVERS

Let \mathcal{O}_Γ be the orbicomplex with fundamental group W_Γ constructed in Section 3. In this section we construct a covering space \mathcal{X} of \mathcal{O}_Γ so that $\pi_1(\mathcal{X})$ is an index 16 torsion-free subgroup of $\pi_1(\mathcal{O}_\Gamma) = W_\Gamma$. Examples appear in Figures 4.3 and 4.4. The space \mathcal{X} will be a surface amalgam with each connected surface in \mathcal{X} having positive genus (so that we can obtain further covers by applying Lemma 2.12). We describe the construction using the terminology of half-coverings, which we define in Section 4.1. The surfaces S_β , which cover the branch orbifolds \mathcal{P}_β , and $S_{\mathcal{A}}$, which cover the non-branch orbifolds \mathcal{A} , are constructed in Sections 4.2 and 4.3 respectively. Finally in Section 4.4, we explain how to glue the S_β and $S_{\mathcal{A}}$ together to obtain \mathcal{X} .

4.1. Half-coverings. In this section we define half-coverings of general bipartite graphs, and a particular half-covering $\mathcal{H}(T)$ where T is a bipartite tree.

Given a graph Λ which contains no loops, for each vertex $x \in V(\Lambda)$, let $\Lambda(x)$ the set of edges of Λ which are incident to x . Now let Λ and Λ' be (unoriented) graphs, with associated maps $\epsilon : E(\Lambda) \rightarrow V(\Lambda)^2/C_2$ and $\epsilon' : E(\Lambda') \rightarrow V(\Lambda')^2/C_2$. (See Section 2.1 for graph-theoretic definitions.) Recall that a *graph morphism* $\theta : \Lambda \rightarrow \Lambda'$ is a map taking $V(\Lambda)$ to $V(\Lambda')$ and $E(\Lambda)$ to $E(\Lambda')$, so that for all $e \in E(\Lambda)$, if $\epsilon(e) = [x, y]$ then $\epsilon'(\theta(e)) = [\theta(x), \theta(y)]$.

Definition 4.1. Let Λ and Λ' be bipartite graphs with vertex sets $V(\Lambda) = V_1 \sqcup V_2$ and $V(\Lambda') = V'_1 \sqcup V'_2$, respectively. A graph morphism $\theta : \Lambda \rightarrow \Lambda'$ is a *half-covering* if:

- (1) For $i = 1, 2$, the map θ takes V_i to V'_i .
- (2) For all $x \in V_1$, the restriction of θ to $\Lambda(x)$ is a bijection onto $\Lambda'(\theta(x))$.
- (3) For all $y \in V_2$, and for every edge $e' \in \Lambda'(\theta(y))$, there is an $e \in \Lambda(y)$ so that $\theta(e) = e'$.

If there is a half-covering $\theta : \Lambda \rightarrow \Lambda'$ then we say that Λ *half-covers* Λ' .

In short, a half-covering is a morphism of bipartite graphs which preserves the bipartition, is locally bijective at vertices of Type 1, and is locally surjective at vertices of Type 2. (In Section 9, we compare half-coverings with the *weak coverings* in [1].)

In several of our constructions we will use half-coverings of the following particular form. Examples appear in Figures 4.3 and 4.4.

Definition 4.2 (The graph $\mathcal{H}(T)$ half-covering a tree T). Let T be a bipartite tree with vertex set $V(T) = V_1 \sqcup V_2$. Let $\mathcal{H}(T)$ be the bipartite graph defined as follows.

- (1) The vertex set $V(\mathcal{H}(T))$ equals $V'_1 \sqcup V'_2$, where V'_1 consists of two disjoint copies of V_1 , and V'_2 is a copy of V_2 .
- (2) Each edge of $\mathcal{H}(T)$ connects a vertex in V'_1 to one in V'_2 . Suppose $u \in V_1$ corresponds to u' and u'' in V'_1 and $v \in V_2$ corresponds to v' in V'_2 . Then u' and u'' are adjacent to v' in $\mathcal{H}(T)$ if and only if u is adjacent to v in T .

By construction, the morphism $\mathcal{H}(T) \rightarrow T$ induced by sending each vertex in $V(\mathcal{H}(T))$ to the corresponding vertex in V_1 or V_2 (according to the identification of V'_1 with two copies of V_1 and V'_2 with V_2) is a half-covering.

4.2. Covering the branch orbifolds. Let β be a branch in Γ with n_β vertices in total. The orbifold \mathcal{P}_β constructed in Section 3.1 has underlying space P a right-angled p -gon with $p = n_\beta + 1 \geq 5$. We now construct a connected surface S_β with genus $2(p - 4) \geq 2$ and 2 boundary components so that S_β is a 16-fold cover of \mathcal{P}_β .

The surface S_β we construct will be tessellated by 16 right-angled p -gons, so that:

- each p -gon has exactly one edge in a boundary component of S_β ;
- the two boundary components of S_β each contain 8 edges; and
- types can be assigned to the edges of this tessellation and to the edges of the p -gon P , such that there is a type-preserving map from S_β to P which takes each edge in a boundary component of S_β to the (unique) non-reflection edge of \mathcal{P}_β .

It follows that the type-preserving map $S_\beta \rightarrow P$ induces a degree 16 covering map from the surface S_β to the orbifold \mathcal{P}_β . (More precisely, we can consider the trivial complex of groups $\mathcal{G}_1(S_\beta)$ over this tessellation of S_β , that is, the complex of groups in which each local group is trivial. The type-preserving map $S_\beta \rightarrow P$ then induces a covering of complexes of groups from $\mathcal{G}_1(S_\beta)$ to the simple complex of groups \mathcal{P}_β ; see [4] for the general definition of a covering of complexes of groups. This induced covering is 16-sheeted since each face group in $\mathcal{G}_1(S_\beta)$ and in \mathcal{P}_β is trivial, and S_β contains 16 p -gons while P is one p -gon.)

For the construction of S_β , we consider two cases, $p \geq 5$ odd and $p \geq 6$ even.

Case 1: $p \geq 5$ is odd. We obtain a tessellated surface S_β by gluing together, in a type-preserving manner, 16 copies of the right-angled p -gon “jigsaw puzzle piece” shown on the top left in Figure 4.1. Each piece is straight on the bottom and sides, while along the top we have $\frac{p-5}{2}$ full scoops and $\frac{p-5}{2} + 1$ horizontal edges, and there is one half-scoop in the top right corner. (So there are $3 + 2\frac{p-5}{2} + 1 + 1 = p$ sides in total.) Glue 16 of these pieces together into an 8-by-2 block as in Figure 4.1. Now glue the left and right boundaries of this block as indicated by the arrows. The resulting surface will be a sphere with 2 boundary components corresponding to non-reflection edges (these are the outer

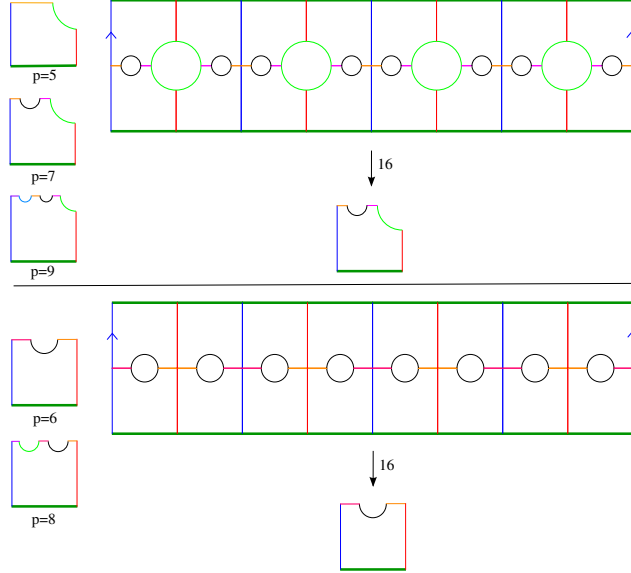

FIGURE 4.1. On the left are the “jigsaw puzzle pieces” in the odd and even cases. On the right are the degree 16 covers constructed by gluing the pieces together. The left and right blue boundaries are glued and the center circles are glued in pairs to construct a surface with two boundary components, drawn in green.

horizontal edges drawn in thick lines; they form 2 cycles of length 8 after the gluing), 4 boundary components corresponding to the half-scoops, and $\frac{p-5}{2} \times 8$ boundary components corresponding to the full scoops. These boundary components contain 8, 4, and 2 edges respectively. The final step to obtain S_β is to glue together the boundary components coming from half-scoops and full-scoops in type-preserving pairs.

Case 2: $p \geq 6$ is even. In this case we use similar jigsaw puzzle pieces to Case 1, except that now we have $\frac{p-4}{2}$ full scoops along the top, as shown on the bottom left in Figure 4.1. Glue 16 of these pieces together into an 8-by-2 block as shown in Figure 4.1, and identify the left and right boundaries as indicated by the arrows. The resulting surface will be a sphere with 2 boundary components corresponding to non-reflection edges and $\frac{p-4}{2} \times 8$ boundary components corresponding to the scoops along the top edge of the piece. The final step to obtain S_β is to glue together these latter boundary components in type-preserving pairs.

4.3. Covering the essential vertex and non-branch orbifolds. Let A be a subset of vertices of Γ so that $\langle A \rangle$ is the stabilizer of a Type 2 vertex in the JSJ decomposition of W_Γ , and let $L \geq 2$ be the number of essential vertices of A . In this section, we assume that $L \geq 3$ and construct a connected surface S_A which is a 16-fold cover of the orbifold \mathcal{A} . (See Section 3.2 for the construction of \mathcal{A} .) The surface S_A will have genus at least 2 and 2ℓ boundary components, where $\ell \geq 1$ is the valence in the JSJ decomposition of the vertex with stabilizer $\langle A \rangle$. An illustration of the construction appears in Figure 4.2.

As in Section 3.2, we will first consider the essential vertex orbifold \mathcal{Q}_A . We will cover \mathcal{Q}_A by a connected surface S_A with genus $3L - 7 \geq 2$ and $2L$ boundary components. Recall that the underlying space of \mathcal{Q}_A is a right-angled $2L$ -gon Q . The surface S_A we construct will be tessellated by 16 right-angled $2L$ -gons, so that:

- each $2L$ -gon has its alternate edges in boundary components of S_A ;

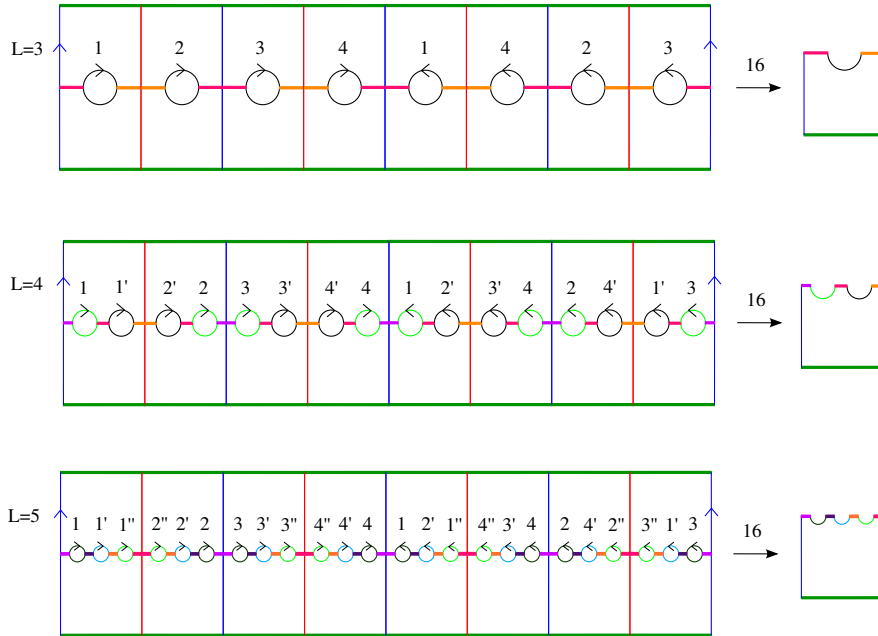

FIGURE 4.2. On the right are orbifolds with $2L$ sides which alternate between reflection edges (drawn in thin lines) and non-reflection edges (drawn in thick lines). On the left are their degree 16 covers. The blue boundaries of the covers are glued and the center circles are glued as indicated. After gluing, the center horizontal arcs are cut to obtain a surface with $2L$ boundary components.

- each boundary component of S_A contains 8 edges; and
- types can be assigned to the edges of this tessellation of S_A and to the edges of the $2L$ -gon Q , such that there is a type-preserving map from S_A to Q which takes each edge in a boundary component of S_A to a non-reflection edge of Q_A . In particular, each boundary component of S_A has the same type as a non-reflection edge of Q_A , and S_A has two boundary components of each type.

As for branch orbifolds in Section 4.2 above, it follows that the type-preserving map $S_A \rightarrow Q$ induces a degree 16 covering map from the surface S_A to the orbifold Q_A .

Start with the 8 by 2 block of jigsaw puzzle pieces from the case $p = 2L \geq 6$ even above. The non-reflection edges will be the horizontal edges of the puzzle piece. We will first glue this into a surface with just 2 boundary components of the same type, this type being one of the non-reflection edges of Q_A . We will then cut along $L - 1$ curves which have types the other non-reflection edges of Q_A , to obtain a connected surface with $2 + 2(L - 1) = 2L$ boundary components, and with 2 boundary components for every type of non-reflection edge of Q_A .

The first stage is to glue together the left and right edges of the block, as indicated by arrows. We then glue pairs of boundary components which consist of 2 edges. This is done in such a way that the inner horizontal edges of the 8 by 2 block, those coming from the top edges of the jigsaw piece, form cycles of a single type of length 8. For each non-reflection type, there is one such cycle of 8 edges.

Now cut along these cycles of length 8. There are then 2 boundary components of each non-reflection type, each consisting of 8 edges. We can carry out the gluing in the previous paragraph

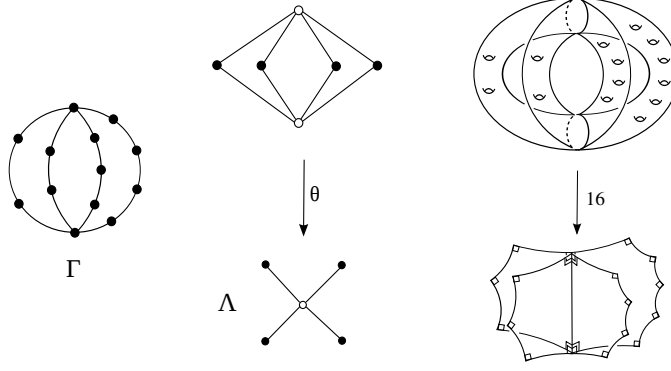

FIGURE 4.3. The graph Γ is a generalized Θ -graph, and the graph Λ is the JSJ graph of W_Γ . On the right is the degree 16 cover $\mathcal{X}_\Gamma \rightarrow \mathcal{O}_\Gamma$, where \mathcal{O}_Γ is the orbifold described in Section 3.3. In the center is the half-covering Θ from the JSJ graph of \mathcal{X}_Γ to the JSJ graph of \mathcal{O}_Γ .

so that the resulting surface is connected: we just need to glue at least one top half of a scoop to the bottom half of a scoop.

We now describe the surface S_A which 16-fold covers the orbifold \mathcal{A} . If A consists entirely of essential vertices, then we put $S_A = S_A$. Otherwise, for each branch β so that the vertex set of β is in the set A , we glue S_β to S_A as follows. Recall that all edges in the tessellations of S_β and S_A have types, that these types are preserved by the covering maps $S_\beta \rightarrow \mathcal{P}_\beta$ and $S_A \rightarrow \mathcal{Q}_A$, and that each boundary component of S_β and S_A has 8 edges. Recall also that \mathcal{A} is obtained by gluing \mathcal{P}_β to \mathcal{Q}_A along a non-reflection edge in a type-preserving manner, for each branch β with vertex set in A . For all such β , we now glue one boundary component of S_β to one boundary component of S_A with its same type, and the other boundary component of S_β to the other boundary component of S_A with its same type, so that these gluings match up edges and vertices of the existing tessellations, and so that at each vertex of the resulting tessellation, the incident edges have exactly two types.

Finally, we erase the edges in the resulting tessellation which were in boundary components of S_A , and denote the resulting tessellated surface by S_A . Note that S_A is still tessellated by right-angled polygons whose edges have well-defined type. By construction, the 16-fold coverings $S_\beta \rightarrow \mathcal{P}_\beta$ and $S_A \rightarrow \mathcal{Q}_A$ induce a 16-fold covering $S_A \rightarrow \mathcal{A}$.

We observe that since S_A has genus $3L - 7 \geq 2$, the surface S_A has genus at least 2. Also, the surface S_A has two boundary components for each non-reflection edge of \mathcal{A} . Now by construction of the orbifold \mathcal{O}_Γ in Section 3.3, the number of non-reflection edges of \mathcal{A} equals the valence $\ell \geq 1$ of the vertex stabilized by $\langle A \rangle$ in the JSJ decomposition of W_Γ . Hence S_A has 2ℓ boundary components.

4.4. The surface amalgam \mathcal{X} . We now construct a surface amalgam \mathcal{X} which 16-fold covers the orbifold \mathcal{O}_Γ , by gluing together certain surfaces S_β constructed in Section 4.2 and all of the surfaces S_A constructed in Section 4.3. Examples appear in Figures 4.3 and 4.4.

Let Λ be the JSJ graph for W_Γ and recall that Λ is a bipartite tree. Let $\mathcal{H}(\Lambda)$ be the graph from Definition 4.2 which half-covers Λ . For each $v \in V_2(\Lambda)$, we write v' for the corresponding vertex in $V_2(\mathcal{H}(\Lambda))$. Now for all $v \in V_2(\Lambda)$, let S_v be the surface S_β , if v has stabilizer W_β for β a branch of Γ , and let S_v be the surface S_A , if v has stabilizer $\langle A \rangle$ with A not equal to the vertex set of a branch of Γ . Then the collection of surfaces $\{S_v \mid v \in V_2(\Lambda)\} = \{S_v \mid v' \in V_2(\mathcal{H}(\Lambda))\}$ is in bijection with the Type 2 vertices of $\mathcal{H}(\Lambda)$.

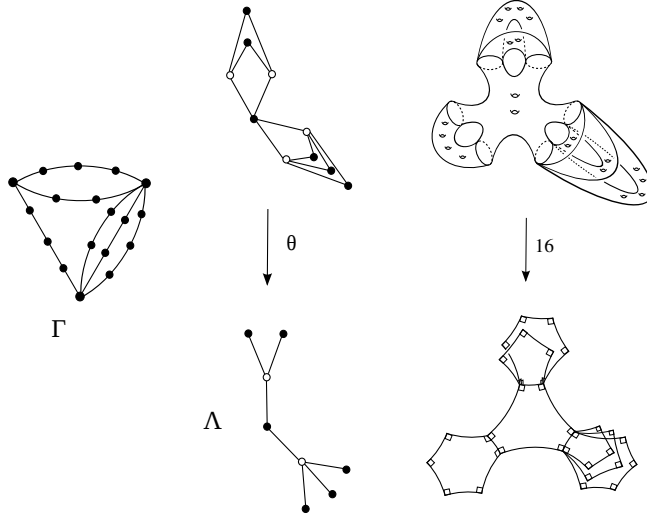

FIGURE 4.4. The graph Γ is a cycle of generalized Θ -graphs, and the graph Λ is the JSJ graph of W_Γ . On the right is the degree 16 cover $\mathcal{X}_\Gamma \rightarrow \mathcal{O}_\Gamma$, where \mathcal{O}_Γ is the orbicomplex described in Section 3.3. In the center is the half-covering Θ from the JSJ graph of Λ to the JSJ graph of \mathcal{O}_Γ .

We now obtain \mathcal{X} by gluing together the surfaces $\{S_v\}$ along boundary components, according to the adjacencies in the graph $\mathcal{H}(\Lambda)$. (In fact, the JSJ graph of \mathcal{X} will be $\mathcal{H}(\Lambda)$.) By construction, each S_v has 2ℓ boundary components, where $\ell \geq 1$ is the valence of v in Λ . Since v' has valence 2ℓ in $\mathcal{H}(\Lambda)$, each S_v has number of boundary components equal to the valence of v' . We now relabel the boundary components of S_v using the vertices of $\mathcal{H}(\Lambda)$ which are adjacent to v' , as follows. Recall that the boundary components of S_v come in pairs which cover the same non-reflection edge (in either \mathcal{P}_β or \mathcal{A}), and so have type $\{a, b\}$ where $\langle a, b \rangle$ is the stabilizer of a Type 1 vertex in Λ . For each $u \in V_1(\Lambda)$ with stabilizer $\langle a, b \rangle$, with corresponding Type 1 vertices u' and u'' in $\mathcal{H}(\Lambda)$, and for each v adjacent to u in Λ , we label one boundary component of S_v of type $\{a, b\}$ by u' and the other by u'' . Now every boundary component in the collection $\{S_v \mid v' \in V_2(\mathcal{H}(\Lambda))\}$ has been assigned a type in $V_1(\mathcal{H}(\Lambda))$, and for each $v \in V_1(\Lambda)$, there is a bijection between the types of boundary components of S_v and the vertices adjacent to v' in $\mathcal{H}(\Lambda)$. We then glue together all boundary components in the collection $\{S_v\}$ which have the same type, so that these gluings match up edges and vertices of the existing tessellations. The resulting surface amalgam is \mathcal{X} . By construction, the 16-fold covers $S_\beta \rightarrow \mathcal{P}_\beta$ and $S_{\mathcal{A}} \rightarrow \mathcal{A}$ induce a 16-fold cover $\mathcal{X} \rightarrow \mathcal{O}_\Gamma$.

5. GENERALIZED Θ -GRAPHS

In this section we prove Theorem 1.8, which gives the commensurability classification of right-angled Coxeter groups with defining graph a 3-convex generalized Θ -graph. We remark that by Corollary 2.1, the JSJ graph of such a group is a k -valent star, so in particular, the JSJ graph is a tree of diameter 2.

Let W_Θ and $W_{\Theta'}$ be right-angled Coxeter groups whose defining graphs are 3-convex generalized Θ -graphs $\Theta = \Theta(n_1, \dots, n_k)$ and $\Theta' = \Theta(n'_1, \dots, n'_{k'})$ respectively, with $k, k' \geq 3$. If Θ has branches β_i for $1 \leq i \leq k$, then W_Θ is the fundamental group of the orbicomplex $\mathcal{O} = \mathcal{O}_\Theta$ constructed in Section 3, obtained by gluing together the branch orbifolds $\mathcal{P}_i = \mathcal{P}_{\beta_i}$, for $1 \leq i \leq k$, along their non-reflection edge. Since $W_i = W_{\beta_i}$ is the fundamental group of \mathcal{P}_i , the Euler characteristic vector

of W_Θ from Definition 1.7 is $v = (\chi(W_1), \dots, \chi(W_k))$. Similarly, $W_{\Theta'}$ is the fundamental group of $\mathcal{O}' = \mathcal{O}_{\Theta'}$ obtained by gluing together the branch orbifolds $\mathcal{P}'_i = \mathcal{P}_{\beta'_i}$, for $1 \leq i \leq k'$, and $W_{\Theta'}$ has Euler characteristic vector $v' = (\chi(W'_1), \dots, \chi(W'_{k'}))$ where $W'_i = W_{\beta'_i}$.

5.1. Sufficient conditions for commensurability. Suppose that the vectors v and v' are commensurable. Then by definition, $k = k'$ and there exist integers $K, K' \geq 1$ so that $Kv = K'v'$. Let a and b be the two essential vertices of Θ . Let r_a be the subcomplex of \mathcal{O} consisting of all reflection edges with local group $\langle a \rangle$ (so r_a is a star of valence k), and let $r_b \subset \mathcal{O}$ be the corresponding subcomplex for b . An immediate generalization of [6, Section 3.1] is that, for any positive integer R , there is a degree R orbicomplex covering $R\mathcal{O} \rightarrow \mathcal{O}$ given by unfolding R times along copies of r_a and r_b so that the central branching edge of $R\mathcal{O}$ forms a geodesic path. An easy counting argument then proves that the orbicomplexes $K\mathcal{O}$ and $K'\mathcal{O}'$ are homeomorphic, hence have isomorphic fundamental groups which are finite-index subgroups of W_Θ and $W_{\Theta'}$, respectively. Therefore W_Θ and $W_{\Theta'}$ are commensurable.

5.2. Necessary conditions for commensurability. The proof of the necessary conditions in Theorem 1.8 follows from a slight generalization of [23, Proposition 3.3.2]. In that setting, it was assumed that the analogs of \mathcal{O} and \mathcal{O}' had the same Euler characteristic, while here, $\chi(W_\Theta) = \chi(\mathcal{O})$ and $\chi(W_{\Theta'}) = \chi(\mathcal{O}')$ could be unequal. The proof from [23] can thus be altered as follows.

Suppose that the groups W_Θ and $W_{\Theta'}$ are commensurable. Then they are quasi-isometric, and by [7, Theorem 3.36], we have $k = k'$. Since W_Θ and $W_{\Theta'}$ are virtually torsion-free, they have isomorphic torsion-free, finite-index subgroups $H \leq W_\Theta$ and $H' \leq W_{\Theta'}$. Then the corresponding covers \mathcal{X} and \mathcal{X}' of \mathcal{O} and \mathcal{O}' are surface amalgams. Let D and D' be the degrees with which \mathcal{X} and \mathcal{X}' respectively cover \mathcal{O} and \mathcal{O}' . By Theorem 2.9, there is a homeomorphism $f : \mathcal{X} \rightarrow \mathcal{X}'$ that induces the isomorphism between H and H' . Suppose

$$\begin{aligned} \chi(W_1) = \chi(W_2) = \dots = \chi(W_s) &> \chi(W_{s+1}) \geq \dots \geq \chi(W_k), \text{ and} \\ \chi(W'_1) = \chi(W'_2) = \dots = \chi(W'_t) &> \chi(W'_{t+1}) \geq \dots \geq \chi(W'_k) \end{aligned}$$

for some $s, t \leq k$. Without loss of generality, $D \cdot \chi(W_1) \geq D' \cdot \chi(W'_1)$, and if $D \cdot \chi(W_1) = D' \cdot \chi(W'_1)$, then $s \geq t$. The remainder of the proof [23, Proposition 3.3.2] may now be applied with the first and last line of the main equation in the proof changed to account for the fact that the degrees of the covering maps are different.

6. NECESSARY CONDITIONS FOR CYCLES OF GENERALIZED Θ -GRAPHS

In this section, we establish our necessary conditions for the commensurability of right-angled Coxeter groups defined by cycles of generalized Θ -graphs, from Theorem 1.12. We show:

Proposition 6.1. *Let W and W' be as in Theorem 1.12. If W and W' are commensurable, then at least one of (1) and (2) from Theorem 1.12 holds.*

We fix notation and explain the three cases we will consider in Sections 6.1 and 6.2. Case 1 is proved in Section 6.3. We establish some results for both Cases 2 and 3 in Section 6.4, then complete the proof of Case 2 in Section 6.5 and that of Case 3 in Section 6.6.

6.1. Notation. Suppose W and W' as in Theorem 1.12 are commensurable. We continue all notation from Section 1.1. In addition, let \mathcal{O}_Γ and $\mathcal{O}_{\Gamma'}$ be the orbicomplexes with fundamental groups $W = W_\Gamma$ and $W' = W_{\Gamma'}$, respectively, constructed in Section 3, and let \mathcal{A} and \mathcal{A}' be the (unique) non-branch orbifolds in \mathcal{O}_Γ and $\mathcal{O}_{\Gamma'}$, with fundamental groups W_A and $W_{A'}$, respectively. For each $i \in I$ and $1 \leq j \leq r_i$, let \mathcal{P}_{ij} be the branch orbifold in \mathcal{O}_Γ with fundamental group

$W_{ij} := W_{\beta_{ij}}$, and let \mathcal{O}_i be the sub-orbicomplex of \mathcal{O}_Γ obtained by gluing together the r_i orbifolds \mathcal{P}_{ij} along their non-reflection edge. Then $\pi_1(\mathcal{O}_i) = W_{\Theta_i}$ for each $i \in I$. Similarly define \mathcal{P}'_{kl} , W'_{kl} , and \mathcal{O}'_k with $\pi_1(\mathcal{O}'_k) = W_{\Theta'_k}$ for each $k \in I'$ and $1 \leq l \leq r'_k$. We write E_i for the i 'th *branching edge* of \mathcal{O}_Γ , that is, the non-reflection edge along which \mathcal{O}_i is glued to \mathcal{A} , and similarly write E'_k for the k 'th branching edge of $\mathcal{O}_{\Gamma'}$.

If $r_i = r = r'_k$ for each $i \in I$ and each $k \in I'$, then for all $1 \leq j \leq r$ we define \mathcal{R}_j to be the disjoint union of the “ j 'th ring” of branch orbifolds $\{\mathcal{P}_{ij} \mid i \in I\}$ in \mathcal{O}_Γ . (Note that, by construction, if $i_1 \neq i_2 \in I$ then the underlying spaces of $\mathcal{P}_{i_1 j}$ and $\mathcal{P}_{i_2 j}$ are disjoint polygons.) Since we are taking a disjoint union, the fundamental group of \mathcal{R}_j is the free product of the groups $W_{ij} = \pi_1(\mathcal{P}_{ij})$ over $i \in I$, even though some of the W_{ij} may have a generator of W in common. Hence $\chi(\pi_1(\mathcal{R}_j)) = \sum_{i \in I} \chi(W_{ij}) = \sum_{i \in I} \chi_{ij} = \chi_j$. Similarly, for each $1 \leq j \leq r$, we define $\mathcal{R}'_j \subset \mathcal{O}_{\Gamma'}$ so that $\chi(\pi_1(\mathcal{R}'_j)) = \chi'_j$.

Let $\rho : \mathcal{X} \rightarrow \mathcal{O}_\Gamma$ and $\rho' : \mathcal{X}' \rightarrow \mathcal{O}_{\Gamma'}$ be the degree 16 torsion-free covers from Section 4. Then $\pi_1(\mathcal{X})$ and $\pi_1(\mathcal{X}')$ are commensurable as well. Let $\eta : \mathcal{Y} \rightarrow \mathcal{X}$ and $\eta' : \mathcal{Y}' \rightarrow \mathcal{X}'$ be covers corresponding to isomorphic finite-index subgroups of $\pi_1(\mathcal{X})$ and $\pi_1(\mathcal{X}')$, and set $\pi = \eta \circ \rho$ and $\pi' = \eta' \circ \rho'$. Let D and D' be the degrees of the covering maps $\pi : \mathcal{Y} \rightarrow \mathcal{O}_\Gamma$ and $\pi' : \mathcal{Y}' \rightarrow \mathcal{O}_{\Gamma'}$, respectively. Finally, let $f : \mathcal{Y} \rightarrow \mathcal{Y}'$ be the homeomorphism guaranteed by Theorem 2.9.

6.2. Cases. To prove Proposition 6.1, we consider three cases, by comparing the subsets $f(\pi^{-1}(\mathcal{A}))$ and $\pi'^{-1}(\mathcal{A}')$ of the surface amalgam \mathcal{Y}' . Note first that since \mathcal{A} (respectively, \mathcal{A}') contains every branching edge of \mathcal{O}_Γ (respectively, $\mathcal{O}_{\Gamma'}$), the sets $f(\pi^{-1}(\mathcal{A}))$ and $\pi'^{-1}(\mathcal{A}')$ will always have non-empty intersection containing all branching curves in \mathcal{Y}' . We write $f(\pi^{-1}(\mathcal{A})) \overset{\circ}{\cap} \pi'^{-1}(\mathcal{A}') = \emptyset$ if the *interiors* of $f(\pi^{-1}(\mathcal{A}))$ and $\pi'^{-1}(\mathcal{A}')$ are disjoint, that is, these subsets of \mathcal{Y}' have no surfaces in common, and we write $f(\pi^{-1}(\mathcal{A})) \overset{\circ}{\cap} \pi'^{-1}(\mathcal{A}') \neq \emptyset$ if the *interiors* of $f(\pi^{-1}(\mathcal{A}))$ and $\pi'^{-1}(\mathcal{A}')$ are non-disjoint, that is, these subsets of \mathcal{Y}' have at least one surface in common. The cases we consider, and their consequences, are as follows:

Case 1. If $f(\pi^{-1}(\mathcal{A})) = \pi'^{-1}(\mathcal{A}')$, we show that condition (1) holds.

Case 2. If $f(\pi^{-1}(\mathcal{A})) \overset{\circ}{\cap} \pi'^{-1}(\mathcal{A}') = \emptyset$, we show that condition (2) holds.

Case 3. If $f(\pi^{-1}(\mathcal{A})) \neq \pi'^{-1}(\mathcal{A}')$ and $f(\pi^{-1}(\mathcal{A})) \overset{\circ}{\cap} \pi'^{-1}(\mathcal{A}') \neq \emptyset$, we construct new homeomorphic finite-sheeted covers of \mathcal{O}_Γ and $\mathcal{O}_{\Gamma'}$ which satisfy Case 1. It follows that condition (1) holds.

6.3. Case 1. In this case we prove:

Proposition 6.2. *If $f(\pi^{-1}(\mathcal{A})) = \pi'^{-1}(\mathcal{A}')$ then condition (1) in Theorem 1.12 holds.*

Proof. Given $i \in I$, consider one component \mathcal{S} of the preimage of \mathcal{O}_i in \mathcal{Y} . The assumption that $f(\pi^{-1}(\mathcal{A})) = \pi'^{-1}(\mathcal{A}')$ implies that $\pi'(f(\mathcal{S}))$ cannot intersect the interior of \mathcal{A}' , and so $f(\mathcal{S})$ must cover some orbicomplex \mathcal{O}'_k in $\mathcal{O}_{\Gamma'}$ with $r'_k = r_i$. If $r_i \geq 3$, then the vectors v_i and v'_k are commensurable by Theorem 1.8 for generalized Θ -graphs.

If $r_i = 2$ and Θ_i has branches β_{i1} and β_{i2} , then form a new Θ -graph Θ with branches β_{i1} and two copies of β_{i2} , and do the same for Θ'_k to get Θ' . Now W_Θ and $W_{\Theta'}$ are commensurable, since we can construct homeomorphic covers of \mathcal{O}_Θ and $\mathcal{O}_{\Theta'}$ from \mathcal{S} and $f(\mathcal{S})$ by adding extra copies of the surfaces mapping to \mathcal{P}_{i2} and \mathcal{P}'_{k2} , respectively. It follows from Theorem 1.8 that the vectors $(\chi_{i1}, \chi_{i2}, \chi_{i2})$ and $(\chi'_{k1}, \chi'_{k2}, \chi'_{k2})$ are commensurable, and so $v_i = (\chi_{i1}, \chi_{i2})$ and $v'_k = (\chi'_{k1}, \chi'_{k2})$ are as well.

Applying the same argument with f^{-1} , we conclude that the sets of commensurability classes of the vectors $\{v_i \mid r_i \geq 2\}$ and $\{v'_k \mid r'_k \geq 2\}$ coincide, proving condition (1)(a).

We now prove (1)(b). It follows from the proof of (1)(a) that

$$f \left(\pi^{-1} \left(\bigcup_{i \in I} \mathcal{O}_i \right) \right) = (\pi')^{-1} \left(\bigcup_{k \in I'} \mathcal{O}'_k \right).$$

Now $\pi_1(\mathcal{O}_i) = W_{\Theta_i}$ for each $i \in I$ and $\pi_1(\mathcal{O}'_k) = W_{\Theta'_k}$ for each $k \in I'$. As the degrees of π and π' are D and D' respectively, we deduce that

$$(6.1) \quad D \left(\sum_{i \in I} \chi(W_{\Theta_i}) \right) = D' \left(\sum_{k \in I'} \chi(W_{\Theta'_k}) \right).$$

Now $f(\pi^{-1}(\mathcal{A})) = (\pi')^{-1}(\mathcal{A}')$ by assumption, and $\pi_1(\mathcal{A}) = W_A$ and $\pi_1(\mathcal{A}') = W_{A'}$, so we also have $D \cdot \chi(W_A) = D' \cdot \chi(W_{A'})$. This together with Equation (6.1) implies (1)(b). \square

6.4. Results for both Cases 2 and 3. In this section we establish some results which are relevant to both of the remaining cases. From now on, we suppose that $f(\pi^{-1}(\mathcal{A})) \neq \pi'^{-1}(\mathcal{A}')$. We start by showing in Lemma 6.3 that all nontrivial generalized Θ -graphs in both Γ and Γ' have the same number of branches. Next, in Proposition 6.4 we prove that the vectors w and w' are commensurable, hence condition (2)(b) in Theorem 1.12 holds. We then color certain sub-orbicomplexes of \mathcal{O}_Γ and $\mathcal{O}_{\Gamma'}$, using the commensurability of w and w' , and make some observations about this coloring in Remark 6.5 and Lemma 6.6. In Remark 6.7 we discuss the structure of the subset $\pi^{-1}(\mathcal{A}) \cup f^{-1}(\pi'^{-1}(\mathcal{A}'))$ of \mathcal{Y} , and then in Lemma 6.9 we consider pre-images of branching edges in \mathcal{O}_Γ and $\mathcal{O}_{\Gamma'}$.

Lemma 6.3. *If $f(\pi^{-1}(\mathcal{A})) \neq \pi'^{-1}(\mathcal{A}')$ then there exists $r \geq 2$ such that $r_i = r'_k = r$ for all $i \in I$ and all $k \in I'$.*

Proof. We prove the contrapositive. If the conclusion fails, then one of the following holds:

- (i) $r_{i_1} \neq r_{i_2}$ for some $r_{i_1}, r_{i_2} \in I$;
- (ii) $r'_{k_1} \neq r'_{k_2}$ for some $r'_{k_1}, r'_{k_2} \in I'$; or
- (iii) $r_i = r$ for all $i \in I$ and $r'_k = s$ for all $k \in I'$, but $r \neq s$.

Suppose (i) holds. If S is any component of $\pi^{-1}(\mathcal{A})$, then S is incident to branching curves in \mathcal{Y} with different branching degrees $r_{i_1} + 1$ and $r_{i_2} + 1$. Then $\pi'(f(S))$ is an orbifold of $\mathcal{O}_{\Gamma'}$ which is incident to branching edges of at least two different degrees. It follows that $\pi'(f(S)) = \mathcal{A}'$ and \mathcal{A}' has branching edges of at least two degrees. Applying the same argument with f^{-1} , we see that $\pi(f^{-1}(T)) = \mathcal{A}$ for each component T of $\pi'^{-1}(\mathcal{A}')$. Thus $f(\pi^{-1}(\mathcal{A})) = \pi'^{-1}(\mathcal{A}')$. The proof is identical if (ii) occurs. Finally, (iii) cannot occur, since the degree of branching is preserved by homeomorphisms. \square

We next extend the techniques used to show that the Euler characteristic vectors of generalized Θ -graphs are commensurable (in the proof of Theorem 1.8) to prove the following.

Proposition 6.4. *The vectors w and w' are commensurable.*

Proof. Let $w = (w_1, \dots, w_{r+1})$ and $w' = (w'_1, \dots, w'_{r+1})$, and suppose

$$w_1 = \dots = w_s > w_{s+1} \geq \dots \geq w_{r+1}, \quad \text{and} \quad w'_1 = \dots = w'_t > w'_{t+1} \geq \dots \geq w'_{r+1}.$$

Without loss of generality, we may assume that $Dw_1 \geq D'w'_1$, and if $Dw_1 = D'w'_1$ then $t \leq s$. For each $1 \leq u \leq r+1$, let $\mathcal{T}_u \subset \mathcal{O}_\Gamma$ be the sub-orbicomplex corresponding to the entry w_u of w . That is, if $w_u = \chi(W_A)$ then $\mathcal{T}_u = \mathcal{A}$, and if $w_u = \chi_j$ then $\mathcal{T}_u = \mathcal{R}_j$. Similarly, let $\mathcal{T}'_u \subset \mathcal{O}_{\Gamma'}$ be the sub-orbicomplex corresponding to the entry w'_u of w' . Note that $f(\pi^{-1}(\mathcal{T}_u)) \subset \mathcal{Y}'$ is a disjoint

collection of connected surfaces with boundary, and the set of boundary curves of these surfaces is exactly the set of branching curves of \mathcal{Y}' .

We now partition $f(\pi^{-1}(\mathcal{T}_1)) \subset \mathcal{Y}'$ as follows:

- $\mathcal{S}_{\mathcal{A}'}$ is the union of the connected surfaces in $f(\pi^{-1}(\mathcal{T}_1))$ which cover \mathcal{A}' .
- For each $k \in I'$, \mathcal{S}_k is the union of the connected surfaces in $f(\pi^{-1}(\mathcal{T}_1))$ which cover a branch orbifold in \mathcal{O}'_k .

Suppose $\mathcal{S}_{\mathcal{A}'}$ forms a cover of degree $D'' \leq D'$ of \mathcal{A}' . This includes the possibility that $\mathcal{S}_{\mathcal{A}'}$ is empty, in which case we put $D'' = 0$. Then $(\pi')^{-1}(E'_k) \cap \mathcal{S}_{\mathcal{A}'}$ covers the branching edge E'_k by degree D'' as well, for each $k \in I'$. For each component surface S of a collection \mathcal{S}_k , let $d(S)$ be the degree of π' restricted to S . Since $(\pi')^{-1}(E'_k)$ covers E'_k by degree D' , it follows that $\sum_{S \subset \mathcal{S}_k} d(S) = D' - D''$

for all $k \in I'$. So,

$$\begin{aligned} Dw_1 &= \chi(\pi^{-1}(\mathcal{T}_1)) = \chi(f(\pi^{-1}(\mathcal{T}_1))) = \chi(\mathcal{S}_{\mathcal{A}'}) + \sum_{k \in I'} \chi(\mathcal{S}_k) \\ &= D'' \chi(\mathcal{A}') + \sum_{k \in I'} \left(\sum_{S \subset \mathcal{S}_k} d(S) \chi(\mathcal{P}'_{kl_S}) \right) \text{ where } S \text{ covers } \mathcal{P}'_{kl_S} \\ &\leq D'' w'_1 + \sum_{k \in I'} \chi(\mathcal{P}'_{k1}) \left(\sum_{S \subset \mathcal{S}_k} d(S) \right) \leq D'' w'_1 + (D' - D'') w'_1 = D' w'_1. \end{aligned}$$

By our assumption, $Dw_1 \geq D' w'_1$. Thus we conclude that $Dw_1 = D' w'_1$. Now, each branching curve in \mathcal{Y}' is incident to exactly s connected surfaces in $f(\pi^{-1}(\mathcal{T}_1)) \cup \dots \cup f(\pi^{-1}(\mathcal{T}_s))$. It follows that $\pi'(f(\pi^{-1}(\mathcal{T}_1)) \cup \dots \cup f(\pi^{-1}(\mathcal{T}_s)))$ must have in its image at least s orbifolds in $\{\mathcal{T}'_1, \dots, \mathcal{T}'_{r+1}\}$, and therefore $t \geq s$. Thus we have $Dw_i = D' w'_i$ for $1 \leq i \leq s = t$. Moreover, $\bigcup_{i=1}^s \pi^{-1}(\mathcal{T}_i) = \bigcup_{i=1}^s \pi'^{-1}(\mathcal{T}'_i)$. Now the above argument can be repeated (at most finitely many times) with the remaining sub-orbicomplexes of \mathcal{O}_Γ and $\mathcal{O}_{\Gamma'}$, which are of strictly smaller Euler characteristic, proving the claim. \square

The next step in both Cases 2 and 3 is to color certain sub-orbicomplexes of \mathcal{O}_Γ and $\mathcal{O}_{\Gamma'}$, as follows. Let $w_0 \in \mathbb{Z}^{r+1}$ be the minimal integral element in the commensurability class of w and w' , so that $w = R w_0$ and $w' = R' w_0$. Let $C = \{c_1, \dots, c_n\}$ be the set of distinct values occurring in w_0 , and assume that $c_1 > \dots > c_n$, so that $w_0 = (c_1, \dots, c_1, c_2, \dots, c_2, \dots, c_n, \dots, c_n)$. We call the elements of the set C the *colors*. Let \mathcal{T}_u and \mathcal{T}'_u be defined as in the proof of Proposition 6.4 for $1 \leq u \leq r$. We now color \mathcal{O}_Γ and $\mathcal{O}_{\Gamma'}$ so that \mathcal{T}_u has color $c \in C$ if $w_u = R c$ and \mathcal{T}'_u has color $c \in C$ if $w'_u = R' c$. Note that for each color c , there is an $m = m_c$ so that each branching edge E_i (respectively, E'_k) is incident to m branch orbifolds \mathcal{P}_{ij} (respectively, \mathcal{P}'_{kl}) of color c .

Remark 6.5. (The map f preserves colors.) The following equation is an easy consequence of the proof of Proposition 6.4:

$$f(\pi^{-1}(\{\mathcal{T}_u \mid \mathcal{T}_u \subset \mathcal{O}_\Gamma \text{ has color } c\})) = \pi'^{-1}(\{\mathcal{T}'_u \mid \mathcal{T}'_u \subset \mathcal{O}_{\Gamma'} \text{ has color } c\}).$$

It also follows that orbifolds of the same color attached to the same edge in \mathcal{O}_Γ or $\mathcal{O}_{\Gamma'}$ are identical:

Lemma 6.6. *For $i \in I$, if \mathcal{P}_{ij_1} and \mathcal{P}_{ij_2} have the same color c , then $\chi_{ij_1} = \chi_{ij_2}$, and \mathcal{P}_{ij_1} and \mathcal{P}_{ij_2} are therefore identical orbifolds. The analogous statement holds for \mathcal{P}'_{kl_1} and \mathcal{P}'_{kl_2} of the same color, where $k \in I'$.*

Proof. Let $i \in I$. If the conclusion fails, we may assume that $\chi_{ij_1} > \chi_{ij_2}$. Then by our assumption that $\chi_{uj} \geq \chi_{uj'}$ whenever $j < j'$, we see that $j_1 < j_2$, and $\sum_{u \in I} \chi_{uj_1} > \sum_{u \in I} \chi_{uj_2}$. This is a contradiction as both of these sums are equal to Rc . Thus $\chi_{ij_1} = \chi_{ij_2}$, and \mathcal{P}_{ij_1} and \mathcal{P}_{ij_2} are identical orbifolds. The proof of the second sentence is identical. \square

For the proofs of Cases 2 and 3, it will be important to understand the structure of the subset $\pi^{-1}(\mathcal{A}) \cup f^{-1}(\pi'^{-1}(\mathcal{A}'))$ of \mathcal{Y} , which is described in the following remark.

Remark 6.7. (Structure of $\pi^{-1}(\mathcal{A}) \cup f^{-1}(\pi'^{-1}(\mathcal{A}'))$). Each of $\pi^{-1}(\mathcal{A})$ and $f^{-1}(\pi'^{-1}(\mathcal{A}'))$ is a disjoint union of (connected) surfaces in \mathcal{Y} . Let \mathcal{W} be the collection of surfaces in \mathcal{Y} which are in both these sets, that is, \mathcal{W} is the collection of surfaces in $\pi^{-1}(\mathcal{A}) \cap f^{-1}(\pi'^{-1}(\mathcal{A}'))$.

Now if S is a surface in $\pi^{-1}(\mathcal{A}) \setminus \mathcal{W}$, then since $\pi'(f(S)) \neq \mathcal{A}'$, for each boundary component of S there is necessarily a surface in $f^{-1}(\pi'^{-1}(\mathcal{A}'))$ incident to this boundary component. If S' is one of these, then $\pi(S') \neq \mathcal{A}$, since S and S' share a boundary curve and S is in $\pi^{-1}(\mathcal{A})$. Hence every other boundary component of S' also borders a component of $\pi^{-1}(\mathcal{A})$. Continuing in this way, we see that the connected component of $\pi^{-1}(\mathcal{A}) \cup f^{-1}(\pi'^{-1}(\mathcal{A}'))$ which contains S has no boundary.

Thus there is a decomposition $\pi^{-1}(\mathcal{A}) \cup f^{-1}(\pi'^{-1}(\mathcal{A}')) = \mathcal{W} \sqcup \mathcal{Z}$, where \mathcal{Z} is a disjoint union of closed surfaces. Moreover, given a component Z of \mathcal{Z} , the branching curves on Z partition it as $Z = Z_{\mathcal{A}} \cup Z_{\mathcal{A}'}$, where $Z_{\mathcal{A}}$ and $Z_{\mathcal{A}'}$ are the (possibly disconnected) subsets of Z consisting of surfaces in \mathcal{Y} such that

$$\pi(Z_{\mathcal{A}}) = \mathcal{A}, \quad \pi(Z_{\mathcal{A}'}) \subset \cup_{i \in I} \mathcal{O}_i, \quad \pi'(f(Z_{\mathcal{A}'})) = \mathcal{A}', \quad \text{and} \quad \pi'(f(Z_{\mathcal{A}})) \subset \cup_{k \in I'} \mathcal{O}'_k.$$

We denote the set of branching curves of a component Z of \mathcal{Z} by the (slightly counterintuitive) notation ∂Z . Then by the description above, $Z_{\mathcal{A}}$ and $Z_{\mathcal{A}'}$ intersect in exactly in ∂Z . So we have that $\partial Z = \partial Z_{\mathcal{A}} = \partial Z_{\mathcal{A}'}$. It follows that the degree of π restricted to $Z_{\mathcal{A}}$, the degree of π restricted to $Z_{\mathcal{A}'}$, and the degree of π restricted to ∂Z are all equal.

Observe that for any component Z of \mathcal{Z} , the collection ∂Z intersects $\pi^{-1}(E_i)$ for each branching edge E_i of \mathcal{O}_{Γ} , as well as $f^{-1}(\pi'^{-1}(E'_k))$ for each branching edge E'_k of $\mathcal{O}_{\Gamma'}$. In what follows it will be necessary to consider the following subset of ∂Z .

Definition 6.8. Let Z be a component of \mathcal{Z} . For $i \in I$ and $k \in I'$, let $\epsilon_{ik} = \epsilon_{ik}(Z)$ be the collection of branching curves in ∂Z which map to E_i under π and to E'_k under $\pi' \circ f$. That is, $\epsilon_{ik} = \pi^{-1}(E_i) \cap f^{-1}(\pi'^{-1}(E'_k)) \cap \partial Z$.

The degrees of π and π' restricted to ϵ_{ik} satisfy the following useful property.

Lemma 6.9. *Let Z be a component of \mathcal{Z} , and let ϵ_{ik} be the curves from Definition 6.8. Then for each $i \in I$ and $k \in I'$, the degree of the map $\pi : \epsilon_{ik} \rightarrow E_i$ is a number $\delta_k = \delta_k(Z)$ which depends on k but not on i , and the degree of the map $\pi' : f(\epsilon_{ik}) \rightarrow E'_k$ is a number $\delta'_i = \delta'_i(Z)$ which depends on i but not on k .*

Moreover, if d and d' are the degrees of π and π' restricted to ∂Z and $f(\partial Z)$ respectively, then we have the following equations:

$$(6.2) \quad \sum_{k \in I'} \delta_k = d \quad \text{and} \quad \sum_{i \in I} \delta'_i = d'.$$

Proof. We write $Z = Z_{\mathcal{A}} \cup Z_{\mathcal{A}'}$ as in Remark 6.7. By definition, no component of $Z_{\mathcal{A}}$ maps to \mathcal{A}' , so we partition $Z_{\mathcal{A}}$ into a disjoint collection of possibly disconnected surfaces \mathcal{S}_k so that $\pi'(f(\mathcal{S}_k))$ is contained in \mathcal{O}'_k for each $k \in I'$. Observe that $\partial \mathcal{S}_k$ contains all curves of $\partial Z = \partial Z_{\mathcal{A}}$ which map to E'_k under $\pi' \circ f$. Thus $\partial \mathcal{S}_k = \cup_{i \in I} \epsilon_{ik}$.

On the other hand, π maps \mathcal{S}_k (and hence $\partial\mathcal{S}_k$) to \mathcal{A} with some degree, say δ_k , which depends on k . Then for any i , the edge E_i has exactly δ_k lifts in \mathcal{S}_k , or equivalently, the degree of π restricted to ϵ_{ik} is δ_k , which is independent of i .

The left equation in (6.2) follows from the fact that $\partial Z = \cup_{k \in I'} \partial\mathcal{S}_k$, so the degree d of π restricted to ∂Z is the sum of the degrees of π restricted to $\partial\mathcal{S}_k$ over all $k \in I'$. The corresponding statements about δ'_i are proved similarly. \square

6.5. Case 2. We now complete the proof of our necessary conditions in the case that $f(\pi^{-1}(\mathcal{A})) \overset{\circ}{\cap} \pi'^{-1}(\mathcal{A}') = \emptyset$. Lemma 6.3 establishes the first sentence of (2) in Theorem 1.12 and Proposition 6.4 proves (2)(b).

Thus it remains to show:

Proposition 6.10. *If $f(\pi^{-1}(\mathcal{A})) \overset{\circ}{\cap} \pi'^{-1}(\mathcal{A}') = \emptyset$ then condition (2)(a) holds.*

Proof. Recall from the discussion preceding Remark 6.5 that $w = R w_0$, where the distinct entries of w_0 correspond to distinct colors. Let \hat{w}_0 denote the vector obtained from w_0 by deleting the p 'th entry, where p is the index of the entry $\chi(W_A)$ of w . We show below that for each $i \in I$, the vector $v_i = (\chi_{i1}, \dots, \chi_{ir})$ is commensurable to \hat{w}_0 . Hence the vectors $\{v_i \mid i \in I\}$ belong to a single commensurability class.

Fix $i \in I$. We begin by showing that there exists a number D'_i such that for $1 \leq j \leq r$, if \mathcal{P}_{ij} has color c , then

$$(6.3) \quad \chi(f(\pi^{-1}(\mathcal{P}_{ij}))) = D'_i R' c.$$

Suppose the color of \mathcal{A}' is c' (with c' possibly equal to c). Partition $f(\pi^{-1}(\mathcal{P}_{ij}))$ into (possibly disconnected) subsurfaces $\mathcal{T}_{\mathcal{A}'}$ and \mathcal{T}_k such that $\pi'(\mathcal{T}_{\mathcal{A}'}) = \mathcal{A}'$ and $\pi'(\mathcal{T}_k)$ is contained in \mathcal{O}'_k , for each $k \in I'$. Note that $\pi^{-1}(\mathcal{P}_{ij})$ contains the full preimage of the branching edge E_i . Let E_{ik} be the collection of all branching curves in \mathcal{Y} which map to E_i under π and to E'_k under $\pi' \circ f$. Then $f(E_{ik})$ consists of $\partial\mathcal{T}_k$ together with some curves from $\partial\mathcal{T}_{\mathcal{A}'}$.

Let \mathcal{W} and \mathcal{Z} be as in Remark 6.7. Then \mathcal{W} is empty, since $f(\pi^{-1}(\mathcal{A})) \overset{\circ}{\cap} \pi'^{-1}(\mathcal{A}') = \emptyset$. Thus E_{ik} is the union of the curves $\epsilon_{ik} = \epsilon_{ik}(\mathcal{Z})$ corresponding to all components Z of \mathcal{Z} . Then it follows from Lemma 6.9 that the degree of π' restricted to $f(E_{ik})$ is a number $D'_i = \sum_{Z \subset \mathcal{Z}} \delta'_i(Z)$, which is independent of k .

Suppose the degree of π' restricted to $\mathcal{T}_{\mathcal{A}'}$ is $D''_i < D'_i$. Then Remark 6.5 implies that for each k , the map π' sends \mathcal{T}_k into the subset of $\cup_{l=1}^r \mathcal{P}'_{kl}$ consisting of orbifolds of color c by total degree $D'_i - D''_i$. By Lemma 6.6, for all \mathcal{P}'_{kl} of color c , the Euler characteristic of $W'_{kl} = \pi_1(\mathcal{P}'_{kl})$ is independent of l , and is equal to $\chi(W'_{kl_0})$ for some l_0 . Now \mathcal{R}'_{l_0} consists of one orbifold of color c for each $k \in I'$, and therefore $\chi'_{l_0} = R' c = \sum_{k \in I'} \chi(W'_{kl_0})$. Thus we obtain Equation (6.3) as follows:

$$\chi(f(\pi^{-1}(\mathcal{P}_{ij}))) = D''_i R' c + \sum_{k \in I'} (D'_i - D''_i) \chi(W'_{kl_0}) = D''_i R' c + (D'_i - D''_i) R' c = D'_i R' c.$$

To complete the proof, note that $\chi(f(\pi^{-1}(\mathcal{P}_{ij}))) = D \chi(W_{ij}) = D \chi_{ij}$, since π is a degree D map. Thus

$$D v_i = D(\chi_{i1}, \dots, \chi_{ir}) = (D'_i R' c_1, \dots, D'_i R' c_1, \dots, \dots, D'_i R' c_n, \dots, D'_i R' c_n) = D'_i R' \hat{w}_0.$$

This proves the first part of (2)(a), and the second part has a similar proof. \square

6.6. **Case 3.** We are now in the case that $f(\pi^{-1}(\mathcal{A})) \overset{\circ}{\cap} \pi'^{-1}(\mathcal{A}') \neq \emptyset$. We show that condition (1) of Theorem 1.12 holds in this case by constructing new homeomorphic finite-sheeted covers of \mathcal{O}_Γ and $\mathcal{O}_{\Gamma'}$ such that the hypothesis of Case 1 is satisfied. More precisely, we show:

Proposition 6.11. *Suppose $f(\pi^{-1}(\mathcal{A})) \overset{\circ}{\cap} \pi'^{-1}(\mathcal{A}') \neq \emptyset$. Then there exist finite-sheeted, torsion-free covers $\mu : \mathcal{M} \rightarrow \mathcal{O}_\Gamma$ and $\mu' : \mathcal{M}' \rightarrow \mathcal{O}_{\Gamma'}$ and a homeomorphism $\tilde{f} : \mathcal{M} \rightarrow \mathcal{M}'$ such that $\tilde{f}(\mu^{-1}(\mathcal{A})) = \mu'^{-1}(\mathcal{A}')$.*

Then by applying case Case 1 to the maps μ, μ' , and \tilde{f} , we get:

Corollary 6.12. *If $f(\pi^{-1}(\mathcal{A})) \overset{\circ}{\cap} \pi'^{-1}(\mathcal{A}') \neq \emptyset$, then condition (1) holds. \square*

To prove Proposition 6.11, we assume that Case 1 does not already hold for $\mathcal{Y}, \mathcal{Y}'$, and f . We observe:

Observation 6.13. Since $f(\pi^{-1}(\mathcal{A})) \overset{\circ}{\cap} \pi'^{-1}(\mathcal{A}') \neq \emptyset$, Remark 6.5 implies that \mathcal{A} and \mathcal{A}' have the same color, say a . As Case 1 does not hold, each of \mathcal{O}_Γ and $\mathcal{O}_{\Gamma'}$ also has orbifolds besides \mathcal{A} and \mathcal{A}' of color a .

Idea of the construction of \mathcal{M} and \mathcal{M}' . As described in Remark 6.7, we have a decomposition $\pi^{-1}(\mathcal{A}) \cap f^{-1}(\pi'^{-1}(\mathcal{A}')) = \mathcal{W} \sqcup \mathcal{Z}$. The hypothesis of Case 1 holds on \mathcal{W} and fails on \mathcal{Z} . Our assumption that Case 1 does not hold for $\mathcal{Y}, \mathcal{Y}'$, and f implies that \mathcal{Z} is nonempty. To construct our new covers, we will cut out each component of \mathcal{Z} (respectively, $f(\mathcal{Z})$) from \mathcal{Y} (respectively, \mathcal{Y}'), and attach new surfaces such that the resulting surface amalgams \mathcal{M} and \mathcal{M}' are homeomorphic covers of \mathcal{O}_Γ and $\mathcal{O}_{\Gamma'}$ respectively, and Case 1 holds.

If Z is a component of \mathcal{Z} , then $Z = Z_{\mathcal{A}} \cup Z_{\mathcal{A}'}$ as in Remark 6.7. By definition, $\pi(Z_{\mathcal{A}}) = \mathcal{A}$ and $\pi'(f(Z_{\mathcal{A}}))$ is contained in the closure of $\mathcal{O}_{\Gamma'} \setminus \mathcal{A}'$. We will replace the (disconnected) surfaces $Z_{\mathcal{A}}$ and $f(Z_{\mathcal{A}})$ with homeomorphic connected surfaces with boundary which cover both \mathcal{A} and \mathcal{A}' . Also, $\pi(Z_{\mathcal{A}'})$ is a collection of orbifolds of color a in the closure of $\mathcal{O}_\Gamma \setminus \mathcal{A}$, while $\pi'(f(Z_{\mathcal{A}'})) = \mathcal{A}'$. We will replace $Z_{\mathcal{A}'}$ and $f(Z_{\mathcal{A}'})$ by a collection of homeomorphic connected surfaces with boundary, so that each such homeomorphic pair covers some orbifold \mathcal{P}_{ij} of color a in \mathcal{O}_Γ and also some orbifold \mathcal{P}'_{kl} of color a in $\mathcal{O}_{\Gamma'}$. After all these replacements, the new covering maps need to extend the already existing covering maps on $\partial Z = \partial Z_{\mathcal{A}} = \partial Z_{\mathcal{A}'}$ and $f(\partial Z)$.

We construct the replacement surfaces in Lemmas 6.14 and 6.15 by passing to our torsion-free covers from Section 4 and then using Lemma 2.12 for constructing further covers. We use Lemma 6.9 to prove the replacement surfaces are homeomorphic. The parity condition in Lemma 2.12 forces the covering maps on the replacement surfaces to have twice the degrees of the restrictions of π and π' to Z and $f(Z)$. Thus to glue in these replacement surfaces, we need to pass to degree 2 covers of \mathcal{Y} and \mathcal{Y}' .

A further difficulty is posed by the fact that each connected replacement surface of the second type maps to a single \mathcal{P}_{ij} and \mathcal{P}'_{kl} , but it may be replacing a collection of surfaces in $Z_{\mathcal{A}'}$ whose image in either \mathcal{O}_Γ or $\mathcal{O}_{\Gamma'}$ contains all orbifolds of color a at either E_i or E'_k . This would make it impossible to extend at least one of π or π' to the new surface. To fix this we pass to a further degree m^2 cover, where m is the number of orbifolds of color a in any $\mathcal{O}_i, i \in I$.

Thus we first construct spaces $\tilde{\mathcal{Y}}$ and $\tilde{\mathcal{Y}'}$ consisting of $2m^2$ disjoint copies of \mathcal{Y} and \mathcal{Y}' . We define new covering maps $\tilde{\pi}$ and $\tilde{\pi}'$ to \mathcal{O}_Γ and $\mathcal{O}_{\Gamma'}$ respectively, designed to make the eventual extensions to \mathcal{M} and \mathcal{M}' possible. Then we cut out all $2m^2$ copies of \mathcal{Z} and replace them with m^2 copies of each of the replacement surfaces in such a way that $\tilde{\pi}$ and $\tilde{\pi}'$ extend. The fact that Case 1 holds follows from the construction.

We now give the details of the construction.

Construction of the replacement surfaces. Let Z be a component of \mathcal{Z} . The following lemma defines the surfaces which will be used to replace copies of $Z_{\mathcal{A}}$.

Lemma 6.14. *Let d and d' be the degrees of π and π' restricted to $\partial Z = \partial Z_{\mathcal{A}}$ and $f(\partial Z)$ respectively. Then there exist connected surfaces T and T' and orbifold covering maps $\alpha : T \rightarrow \mathcal{A}$ and $\alpha' : T' \rightarrow \mathcal{A}'$ of degree $2d$ and $2d'$ respectively such that the following properties hold.*

- (1) *There is a partition $\partial T = \partial T^+ \sqcup \partial T^-$ and homeomorphisms $\beta^{\pm} : \partial T^{\pm} \rightarrow \partial Z$ such that $\alpha = \pi \circ \beta^{\pm}$.*
- (2) *There is a partition $\partial T' = \partial T'^+ \sqcup \partial T'^-$ and homeomorphisms $\beta'^{\pm} : \partial T'^{\pm} \rightarrow f(\partial Z)$ such that $\alpha' = \pi' \circ \beta'^{\pm}$.*
- (3) *There is a homeomorphism $\psi : T \rightarrow T'$ whose restriction to ∂T consists of the maps $(\beta'^{\pm})^{-1} \circ f \circ \beta^{\pm}$.*

Proof. Recall that $\pi = \rho \circ \eta$, where $\rho : \mathcal{X} \rightarrow \mathcal{O}_{\Gamma}$ is the degree 16 torsion-free covering space from Section 4. If $S_{\mathcal{A}} = \rho^{-1}(\mathcal{A})$, then η maps the possibly disconnected surface $Z_{\mathcal{A}}$ to the connected surface $S_{\mathcal{A}}$ by degree $d/16 \in \mathbb{Z}$. We will use Lemma 2.12 to construct a connected cover T of $S_{\mathcal{A}}$ of degree $d/16$.

Let ∂T^+ and ∂T^- be sets of circles, each equal to a copy of ∂Z , and let β^+ and β^- be homeomorphisms from ∂T^+ and ∂T^- respectively to ∂Z . Then $\eta \circ \beta^{\pm}$ a covering map from each circle in ∂T^{\pm} to a circle in $\partial S_{\mathcal{A}}$. Moreover, the sum of the degrees of $\eta \circ \beta^+$ and $\eta \circ \beta^-$ over all circles that cover a given one in $\partial S_{\mathcal{A}}$ is $2(d/16) \in 2\mathbb{Z}$ by construction (since η is a covering map of degree $d/16$ on ∂Z).

Now by Lemma 2.12, there exists a connected surface T and a covering map $\bar{\alpha} : T \rightarrow S_{\mathcal{A}}$ of degree $2d/16$ which extends the maps $\eta \circ \beta^{\pm}$ on $\partial T^+ \sqcup \partial T^-$, because both the prescribed number of boundary components, namely $2 \text{card}(\partial Z)$, and the number $2(d/16)\chi(S_{\mathcal{A}})$ are even. Hence $\alpha = \rho \circ \bar{\alpha}$ is a degree $2d$ covering map from T to \mathcal{A} . This proves (1), and the map $\alpha' : T' \rightarrow \mathcal{A}'$ of degree $2d'$ satisfying (2) is constructed similarly.

To prove (3) we first show that T and T' have the same Euler characteristic. By construction $\chi(T) = d\chi(W_{\mathcal{A}})$ and $\chi(T') = d'\chi(W_{\mathcal{A}'})$, and we now show that these are equal.

As in the proof of Lemma 6.9, we partition $Z_{\mathcal{A}}$ into unions of connected surfaces \mathcal{S}_k for $k \in I'$, where $\pi'(f(\mathcal{S}_k))$ is contained in \mathcal{O}'_k . Observe that the set of boundary components of \mathcal{S}_k is exactly $\cup_{i \in I} \epsilon_{ik}$, and by Lemma 6.9, the degree of π' restricted to $f(\epsilon_{ik})$ is δ'_i . Now the degree of π' restricted to $f(\mathcal{S}_k)$ is exactly the sum of the degrees of π' restricted to $f(\epsilon_{ik})$ over all $i \in I$, and this sum is $\sum_{i \in I} \delta'_i = d'$ (again by Lemma 6.9). Thus we have

$$(6.4) \quad \chi(f(\mathcal{S}_k)) = d'\chi(W'_{kt}),$$

where $W'_{kt} = \pi_1(\mathcal{P}'_{kt})$ for \mathcal{P}'_{kt} a branch orbifold of color a . By Lemma 6.6 all branch orbifolds of color a are identical. So $f(\mathcal{S}_k)$ covers an orbifold identical to \mathcal{P}'_{kt} with total degree d' for each $1 \leq k \leq N'$. Thus we have

$$(6.5) \quad d\chi(W_{\mathcal{A}}) = \chi(Z_{\mathcal{A}}) = \sum_{k \in I'} \chi(f(\mathcal{S}_k)) = d' \sum_{k \in I'} \chi(W'_{kt}) = d' \chi'_t = d' \chi(W_{\mathcal{A}'})$$

where the last equality comes from $\chi'_t = \chi(\pi_1(\mathcal{R}'_t))$, $\chi(W_{\mathcal{A}'}) = \chi(\pi_1(\mathcal{A}'))$, and the fact that \mathcal{A}' and \mathcal{R}'_t have the same color a .

Now T and T' have the same Euler characteristic and the same number of boundary components, so they are homeomorphic. Moreover, we can choose a homeomorphism ψ between them which extends the homeomorphism $(\beta'^{\pm})^{-1} \circ f \circ \beta^{\pm}$ on their boundaries. \square

The following lemma constructs pairs of homeomorphic surfaces which map to fixed pairs of orbifolds \mathcal{P}_{is} and \mathcal{P}'_{kt} . Collections of surfaces of this form will be used to replace copies of $Z_{A'}$.

Lemma 6.15. *Let Z be a component of \mathcal{Z} , and let ϵ_{ik}, δ_k and δ'_i be as in Lemma 6.9. For each i and k such that ϵ_{ik} is nonempty, and for each s and t such that \mathcal{P}_{is} and \mathcal{P}'_{kt} have color a , there exist connected surfaces S and S' and orbifold covering maps $\zeta : S \rightarrow \mathcal{P}_{is}$ and $\zeta' : S' \rightarrow \mathcal{P}'_{kt}$ of degree $2\delta_k$ and $2\delta'_i$ respectively, such that the following properties hold.*

- (1) *There is a partition $\partial S = \partial S^+ \sqcup \partial S^-$ and homeomorphisms $\xi^\pm : \partial S^\pm \rightarrow \partial Z$ such that $\zeta = \pi \circ \xi^\pm$.*
- (2) *There is a partition $\partial S' = \partial S'^+ \sqcup \partial S'^-$ and homeomorphisms $\xi'^\pm : \partial S'^\pm \rightarrow f(\partial Z)$ such that $\zeta' = \pi \circ \xi'^\pm$.*
- (3) *There is a homeomorphism $\varphi : S \rightarrow S'$ whose restriction to ∂S consists of the maps $(\xi'^\pm)^{-1} \circ f \circ \xi^\pm$.*

Proof. As in the proof of Lemma 6.14, we construct covers $S \rightarrow \mathcal{P}_{is}$ and $S' \rightarrow \mathcal{P}'_{kt}$ of the required degrees using Lemma 2.12. By construction, S and S' have homeomorphic boundaries. We show below that $\chi(S) = \chi(S')$. It follows that S and S' are homeomorphic, and we choose a homeomorphism φ between them which extends the homeomorphism $(\xi'^\pm)^{-1} \circ f \circ \xi^\pm$ on their boundaries.

Since $\chi(S) = \delta_k \chi(W_{is}) = \delta_k \chi_{is}$ and $\chi(S') = \delta'_i \chi(W'_{kt}) = \delta'_i \chi'_{kt}$, it is enough to show that $\delta_k \chi_{is} = \delta'_i \chi'_{kt}$. This follows from the two facts below, where d and d' are as in Lemma 6.9.

- (i) $d\chi_s = d'\chi'_t$.
- (ii) $d'\chi'_{kt} = \delta_k \chi_s$ and $d\chi_{is} = \delta'_i \chi'_t$.

More precisely, facts (i) and (ii) give

$$\frac{d'}{d} = \frac{\chi_s}{\chi'_t} = \left(\frac{d'\chi'_{kt}}{\delta_k} \right) \left(\frac{\delta'_i}{d\chi_{is}} \right) = \left(\frac{d'}{d} \right) \left(\frac{\delta'_i \chi'_{kt}}{\delta_k \chi_{is}} \right).$$

This yields $\delta_k \chi_{is} = \delta'_i \chi'_{kt}$ as desired.

Equation (6.5) in the proof of Lemma 6.14 shows that $d\chi(W_A) = d'\chi(W_{A'})$. Now (i) follows from the fact that $\chi_s = \chi(W_A)$ and $\chi'_t = \chi(W_{A'})$. To prove (ii), we recall from the proof of Lemma 6.9 that \mathcal{S}_k covers \mathcal{A} with degree δ_k . This, together with equation (6.4) in the proof of Lemma 6.14 and the fact that $\chi(W_A) = \chi_s$ gives:

$$\delta_k \chi_s = \delta_k \chi(W_A) = \chi(\mathcal{S}_k) = \chi(f(\mathcal{S}_k)) = d'\chi'_{kt}.$$

The proof of the second equation in (ii) is similar. \square

We are now ready to construct the new covers \mathcal{M} and \mathcal{M}' .

Proof of Proposition 6.11. Suppose that each \mathcal{O}_i and \mathcal{O}'_k has m branch orbifolds of color a . Then we will construct homeomorphic surface amalgam covers \mathcal{M} and \mathcal{M}' of \mathcal{O}_Γ and $\mathcal{O}_{\Gamma'}$ of degrees $2m^2D$ and $2m^2D'$ respectively.

New homeomorphic covering spaces $\bar{\mathcal{Y}}$ and $\bar{\mathcal{Y}}'$. Take $2m^2$ disjoint copies of \mathcal{Y} and \mathcal{Y}' to obtain $\bar{\mathcal{Y}}$ and $\bar{\mathcal{Y}}'$. More precisely, for $1 \leq p, q \leq m$, let $\tau_{pq}^\pm : \mathcal{Y} \rightarrow \mathcal{Y}_{pq}^\pm$ and $\tau'_{pq}^\pm : \mathcal{Y}' \rightarrow \mathcal{Y}'_{pq}^\pm$ be homeomorphisms, and set:

$$\bar{\mathcal{Y}} = \left(\bigsqcup_{p,q=1}^m \mathcal{Y}_{pq}^+ \right) \sqcup \left(\bigsqcup_{p,q=1}^m \mathcal{Y}_{pq}^- \right) \quad \text{and} \quad \bar{\mathcal{Y}}' = \left(\bigsqcup_{p,q=1}^m \mathcal{Y}'_{pq}^+ \right) \sqcup \left(\bigsqcup_{p,q=1}^m \mathcal{Y}'_{pq}^- \right).$$

We define the map $\bar{\pi} : \bar{\mathcal{Y}} \rightarrow \mathcal{O}_\Gamma$ as follows. First define an isometry $\sigma : \mathcal{O}_\Gamma \rightarrow \mathcal{O}_\Gamma$ so that if $1 \leq j_1 < \dots < j_m \leq r$ are the indices of the color a orbifolds \mathcal{R}_{j_u} in \mathcal{O}_Γ , then $\sigma(\mathcal{R}_{j_u}) = \mathcal{R}_{j_{u+1}}$, where

$u+1$ is taken mod m , and σ is the identity elsewhere. Then $\bar{\pi}$ is defined on \mathcal{Y}_{pq}^\pm by $\bar{\pi} = \sigma^p \circ \pi \circ (\tau_{pq}^\pm)^{-1}$. Clearly the resulting map $\bar{\pi} : \bar{\mathcal{Y}} \rightarrow \mathcal{O}_\Gamma$ is an orbifold covering map of degree $2m^2D$.

Similarly we choose the analogous isometry $\sigma' : \mathcal{O}'_\Gamma \rightarrow \mathcal{O}'_\Gamma$ and define the corresponding covering map $\bar{\pi}' : \mathcal{Y}' \rightarrow \mathcal{O}'_\Gamma$ of degree $2m^2D'$, by setting $\bar{\pi}' = \sigma'^q \circ \pi' \circ (\tau'_{pq})^{-1}$ on \mathcal{Y}'_{pq} . Finally, we define a homeomorphism $\bar{f} : \bar{\mathcal{Y}} \rightarrow \bar{\mathcal{Y}}'$ by setting $\bar{f} = \tau'^{\pm} \circ f \circ (\tau_{pq}^\pm)^{-1}$ on \mathcal{Y}_{pq}^\pm .

Construction of \mathcal{M} and \mathcal{M}' . Let $\mathcal{Z} \subset \mathcal{Y}$ be as in Remark 6.7. Given a component Z of $\mathcal{Z} \subset \mathcal{Y}$, let ∂Z denote the branching curves it contains. Let $Z_{pq}^\pm = \tau_{pq}^\pm(Z)$ and $\partial Z_{pq}^\pm = \tau_{pq}^\pm(\partial Z)$ denote the corresponding objects in \mathcal{Y}_{pq}^\pm . Let \mathcal{M}_Z be the subspace of $\bar{\mathcal{Y}}$ obtained by cutting out the interiors of all $2m^2$ copies of \mathcal{Z} . More precisely,

$$\mathcal{M}_Z = \bar{\mathcal{Y}} \setminus \left(\bigsqcup_{Z \in \mathcal{Z}} \bigsqcup_{p,q=1}^m (Z_{pq}^\pm \setminus \partial Z_{pq}^\pm) \right).$$

The space \mathcal{M} is obtained by gluing a new collection of surfaces to \mathcal{M}_Z in such a way that each branching curve in \mathcal{M} has a neighborhood homeomorphic to a neighborhood of the corresponding curve in \mathcal{Y} , and moreover there is an extension of $\bar{\pi}|_{\mathcal{M}_Z}$ to a map μ on \mathcal{M} , such that $\bar{\pi}$ and μ agree on such neighborhoods of branching curves. The space \mathcal{M}' is obtained similarly. The surfaces are glued as follows.

Fix a component Z of \mathcal{Z} . We glue two types of surfaces to \mathcal{M}_Z and $f(\mathcal{M}_Z)$ along the curves $\bigsqcup_{p,q=1}^m \partial Z_{pq}^\pm$ and $\bigsqcup_{p,q=1}^m \bar{f}(\partial Z_{pq}^\pm)$ respectively. Let $Z = Z_{\mathcal{A}} \sqcup Z_{\mathcal{A}'}$ as in Remark 6.7.

- (1) (Replacements for $Z_{\mathcal{A}}$.) Construct m^2 copies each of the surfaces T and T' from Lemma 6.14, indexed by $1 \leq p, q \leq m$. Let $\beta_{pq}^\pm : \partial T_{pq} \rightarrow \partial Z$ and $\beta'_{pq}^\pm : \partial T'_{pq} \rightarrow f(\partial Z)$ denote the maps from the lemma. Then T_{pq} is attached to \mathcal{M}_Z by identifying ∂T_{pq}^+ to ∂Z_{pq}^+ via $\tau_{pq}^+ \circ \beta_{pq}^+$, and ∂T_{pq}^- to ∂Z_{pq}^- via $\tau_{pq}^- \circ \beta_{pq}^-$. Similarly T'_{pq} is attached to $f(\mathcal{M}_Z)$ in $\bar{f}(\mathcal{M}_Z)$ via the maps $\tau'_{pq} \circ \beta'_{pq}$. Note that by Lemma 6.14 there are covering maps $\alpha_{pq} : T_{pq} \rightarrow \mathcal{A}$ and $\alpha'_{pq} : T'_{pq} \rightarrow \mathcal{A}'$.
- (2) (Replacements for $Z_{\mathcal{A}'}$.) For each non-empty collection of curves ϵ_{ik} in Z , we glue in m^2 copies of a single surface. Thus $Z_{\mathcal{A}'}$ is replaced by the union of such surfaces for all pairs i, k such that ϵ_{ik} is nonempty.

Fix such an ϵ_{ik} . Construct m^2 copies of the surfaces S and S' described in Lemma 6.15, denoted by S_{pq} and S'_{pq} , with $1 \leq p, q \leq m$. Corresponding to p and q , choose $s = j_p$ and $t = l_q$ in the statement of Lemma 6.15, and let $\zeta_{pq} : S_{pq} \rightarrow \mathcal{P}_{ij_p}$ and $\zeta'_{pq} : S'_{pq} \rightarrow \mathcal{P}'_{kl_q}$ be the covering maps given by the lemma. Let $\xi_{pq}^\pm : \partial S_{pq} \rightarrow \partial Z$ and $\xi'_{pq}^\pm : \partial S'_{pq} \rightarrow f(\partial Z)$ be the associated maps on the boundaries.

We cannot simply attach S_{pq} to ∂Z_{pq}^\pm as in the previous case, because we want to define a covering map μ on \mathcal{M} which agrees with $\bar{\pi}$ on a neighborhood of each branching curve in $\bar{\mathcal{Y}}$. Now $\mu(S_{pq})$ will have to be a single orbifold \mathcal{P}_{ij_s} for some $1 \leq s \leq m$. On the other hand, S_{pq} is replacing a disjoint collection of surfaces in $\mathcal{Y}_{pq}^+ \cup \mathcal{Y}_{pq}^-$ (namely all surfaces in $\tau_{pq}^\pm(Z_{\mathcal{A}'})$ with boundary in $\tau_{pq}^\pm(\epsilon_{ik})$). A priori the image of the union of these surfaces under $\bar{\pi}$ could be all the \mathcal{P}_{ij} of color a . Then for any choice of s there would be some branching curve incident to two surfaces mapping to \mathcal{P}_{ij_s} , and μ would not be an orbifold covering. To take care of this issue, we define the attaching maps as follows.

Let γ be a boundary curve in ∂S_{pq}^+ . Then $\xi_{pq}^+(\gamma)$ is a branching curve of \mathcal{Y} , which is incident to two subsurfaces in Z , say S_1 in $Z_{\mathcal{A}'}$ and S_2 in $Z_{\mathcal{A}}$. Then $\pi(S_1) = \mathcal{P}_{ij_u}$ for some $1 \leq u \leq m$ and $\pi'(f(S_2)) = \mathcal{P}'_{kl_v}$ for some $1 \leq v \leq m$. We then attach the γ boundary of

S_{pq} to $\mathcal{Y}_{(p-u)(q-v)}^+ \cap \mathcal{M}_Z$ via the map $\tau_{(p-u)(q-v)}^+ \circ \xi_{pq}^+$. Note that u and v depend on γ . Now if φ is the homeomorphism from S_{pq} to S'_{pq} given by Lemma 6.15, then we attach the $\varphi(\gamma)$ boundary of S'_{pq} to $\mathcal{Y}_{(p-u)(q-v)} \cap f(\mathcal{M}_Z)$ via the map $\tilde{f} \circ \tau_{(p-u)(q-v)}^+ \circ \xi_{pq}^+ \circ \varphi^{-1}$. We repeat this procedure for each γ in ∂S_{pq}^\pm to attach all the boundary components of S_{pq} to \mathcal{M}_Z and the corresponding boundary components of S'_{pq} to $f(\mathcal{M}_Z)$.

We repeat the above procedure for each $1 \leq p \leq m$ and $1 \leq q \leq m$. This completes the replacement of surfaces corresponding to the copies of the curves ϵ_{ik} . We now do the same for each i and k such that ϵ_{ik} is nonempty.

We claim that at the end of steps (1) and (2), each curve in $\sqcup_{p,q=1}^m \partial Z_{pq}^\pm$ is incident to exactly one surface from (1) and one surface from (2). The first claim is easy. Now suppose (without loss of generality) that $\gamma \in Z_{st}^+$ is incident to two surfaces, say along γ_1 in $S_{p_1q_1}$ and γ_2 in $S_{p_2q_2}$. Then $\xi_{p_1q_1}^+(\gamma_1) = \xi_{p_2q_2}^+(\gamma_2) = (\tau_{st}^+)^{-1}(\gamma)$ in ∂Z , and if u and v are defined as in (2), then $s = p_1 - u = p_2 - u$. Thus $p_1 = p_2$, and similarly $q_1 = q_2$.

Finally, we repeat steps (1) and (2) above for each component Z of \mathcal{Z} to get \mathcal{M} and \mathcal{M}' . Note that since the ∂Z 's for different Z 's partition $\partial \mathcal{Z}$, we see that each branching curve in $\sqcup_{Z \in \mathcal{Z}} \sqcup_{p,q} \partial Z_{pq}^\pm$ is incident to exactly one surface from (1) and one from (2). In fact, if $\gamma \in \partial Z_{pq}^\pm$ for some Z, p and q , then there exist neighborhoods $N_{\mathcal{Y}}(\gamma)$ and $N_{\mathcal{M}}(\gamma)$ in \mathcal{Y} and \mathcal{M} respectively, and a homeomorphism $h_\gamma : N_{\mathcal{Y}}(\gamma) \rightarrow N_{\mathcal{M}}(\gamma)$, which is the identity on $\mathcal{M}_Z \cap N_{\mathcal{Y}}(\gamma)$, maps $N_{\mathcal{Y}}(\gamma) \cap \mathcal{Z}_A$ to the part of $N_{\mathcal{M}}$ coming from the surface from (1), and maps $N_{\mathcal{Y}}(\gamma) \cap \mathcal{Z}_{A'}$ to the part of $N_{\mathcal{M}}$ coming from the surface from (2).

The covering maps μ and μ' , and the homeomorphism \tilde{f} . Define μ and μ' as follows, where $1 \leq p, q \leq m$:

$$\mu = \begin{cases} \bar{\pi} & \text{on } \mathcal{M}_Z \\ \alpha_{pq} & \text{on each } T_{pq} \\ \zeta_{uv} & \text{on each } S_{pq} \end{cases} \quad \text{and} \quad \mu' = \begin{cases} \bar{\pi}' & \text{on } f(\mathcal{M}_Z) \\ \alpha'_{pq} & \text{on each } T'_{pq} \\ \zeta'_{pq} & \text{on each } S'_{pq} \end{cases}$$

The overlap between the domains of the various maps is exactly the set of branching curves $\sqcup_{Z \in \mathcal{Z}} \sqcup_{p,q} \partial Z_{pq}^\pm$. Thus it follows from the definitions of the gluing maps, the definition of $\bar{\pi}$, and items (i) and (ii) in Lemmas 6.14 and 6.15 that μ and μ' are well-defined.

We already know that μ is a covering map away from the branching curves in $\sqcup_{Z \in \mathcal{Z}} \sqcup_{p,q} \partial Z_{pq}^\pm$. If γ is such a branching curve, then the above description of the surfaces incident to γ , together with the fact that μ and $\bar{\pi}$ agree on γ , shows that there is a homeomorphism h from some neighborhood of γ in \mathcal{M} to a neighborhood of γ in \mathcal{Y} such that $\mathcal{M} = \bar{\pi} \circ h$. It follows that μ is an orbifold covering map in a neighborhood of each branching curve. Thus μ , and similarly μ' , are orbifold covering maps.

Finally, define \tilde{f} by setting it equal to \bar{f} on \mathcal{M}_Z , to ψ_{pq} on each surface of the form T_{pq} as in (1) above, and to φ_{pq} on each surface of the form S_{pq} as in (2) above, where ψ_{pq} and φ_{pq} are the homeomorphisms from Lemmas 6.14 and 6.15. Then $\tilde{f} : \mathcal{M} \rightarrow \mathcal{M}'$ is a well-defined homeomorphism, and we have that $\tilde{f}(\mu^{-1}(\mathcal{A})) = \mu'^{-1}(\mathcal{A}')$ \square

This completes the proof of Proposition 6.1.

7. SUFFICIENT CONDITIONS FOR CYCLES OF GENERALIZED Θ -GRAPHS

In this section we establish sufficient conditions for the commensurability of right-angled Coxeter groups defined by cycles of generalized Θ -graphs. We show that conditions (1) and (2) from Theorem 1.12 are sufficient in Sections 7.1 and 7.2, respectively.

7.1. **Sufficiency of condition (1).** We now prove the following result.

Proposition 7.1. *Let $W = W_\Gamma$ and $W' = W_{\Gamma'}$ be as in Theorem 1.12. If condition (1) holds, then W and W' are commensurable.*

By the construction given in Section 4, we have surface amalgams \mathcal{X} and \mathcal{X}' which are finite-sheeted covers of \mathcal{O}_Γ and $\mathcal{O}_{\Gamma'}$, respectively. To prove Proposition 7.1, we will construct homeomorphic surface amalgams \mathcal{Y} and \mathcal{Y}' so that \mathcal{Y} is a finite-sheeted cover of \mathcal{X} and \mathcal{Y}' is a finite-sheeted cover of \mathcal{X}' . It follows that $\pi_1(\mathcal{Y}) \cong \pi_1(\mathcal{Y}')$ has finite index in both $W = \pi_1(\mathcal{O}_\Gamma)$ and $W' = \pi_1(\mathcal{O}_{\Gamma'})$, hence W and W' are abstractly commensurable.

Let Λ and Λ' be the JSJ graphs of W and W' , respectively, and recall from Section 4 that the JSJ graphs of \mathcal{X} and \mathcal{X}' are the half-covers $\mathcal{H}(\Lambda)$ and $\mathcal{H}(\Lambda')$. The surface amalgams \mathcal{Y} and \mathcal{Y}' will have isomorphic JSJ graphs Ψ and Ψ' , with Ψ and Ψ' being half-covers of $\mathcal{H}(\Lambda)$ and $\mathcal{H}(\Lambda')$, respectively. After introducing some notation and constants for use in the proof, in Sections 7.1.1 and 7.1.2 respectively, we construct Ψ and Ψ' in Section 7.1.3. We then construct common covers of the surfaces in \mathcal{X} and \mathcal{X}' in Sections 7.1.4 and 7.1.5. Finally, in Section 7.1.6, we describe how these surfaces are glued together to form homeomorphic surface amalgams \mathcal{Y} and \mathcal{Y}' so that there are finite-sheeted coverings $\mathcal{Y} \rightarrow \mathcal{X}$ and $\mathcal{Y}' \rightarrow \mathcal{X}'$.

7.1.1. *Notation.* We first establish some notation to be used throughout the proof of Proposition 7.1. This includes labeling the vertices of $\mathcal{H}(\Lambda)$ and $\mathcal{H}(\Lambda')$.

Using (1)(a) of Theorem 1.12, let $\mathcal{V}_1, \dots, \mathcal{V}_M$ be the commensurability classes of the Euler characteristic vectors $\{v_i \mid r_i \geq 2\}$ and $\{v'_k \mid r_k \geq 2\}$. For each $1 \leq p \leq M$, let $r_p \geq 2$ be the number of entries of each vector in \mathcal{V}_p , let w_p be the minimal integral element of the commensurability class \mathcal{V}_p , let $\{v_{pq} \mid 1 \leq q \leq N_p\}$ be the vectors from $\{v_i \mid r_i \geq 2\}$ which lie in \mathcal{V}_p , and let $\{v'_{pq'} \mid 1 \leq q' \leq N'_p\}$ be the vectors from $\{v'_k \mid r'_k \geq 2\}$ which lie in \mathcal{V}_p . For each p, q , and q' , let R_{pq} and $R'_{pq'}$ be the (unique) rationals so that $v_{pq} = R_{pq}w_p$ and $v'_{pq'} = R'_{pq'}w_p$.

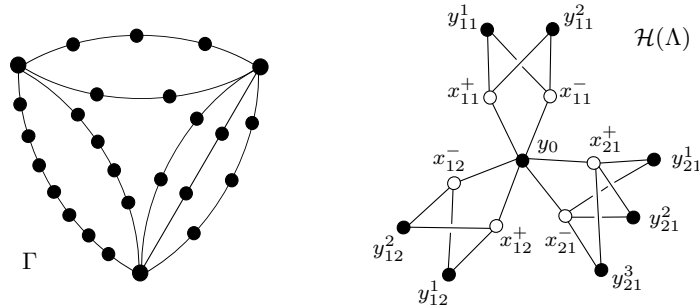

FIGURE 7.1. The graph Γ on the left is an example of a cycle of generalized Θ -graphs in which there are two commensurability classes of Euler characteristic vectors for W_Γ . On the right, the graph $\mathcal{H}(\Lambda)$ is the JSJ graph of the degree 16 torsion-free cover \mathcal{X} of \mathcal{O}_Γ constructed in Section 4. The vertices of $\mathcal{H}(\Lambda)$ are labeled as described in Section 7.1.1.

We use the notation from the previous paragraph to label the vertices of the graphs $\mathcal{H}(\Lambda)$ and $\mathcal{H}(\Lambda')$, as follows. An example of the labeling is given in Figure 7.1. The graph $\mathcal{H}(\Lambda)$ has two

Type 1 vertices for every $r_i \geq 2$, hence has $2 \sum_{p=1}^M N_p$ Type 1 vertices. We label these as:

$$V_1(\mathcal{H}(\Lambda)) = \{x_{pq}^+, x_{pq}^- \mid 1 \leq p \leq M, 1 \leq q \leq N_p\}.$$

The central vertex of $\mathcal{H}(\Lambda)$, which is of Type 2, we denote by y_0 . This vertex is adjacent to every Type 1 vertex, so has valence $2 \sum_{p=1}^M N_p$. For each p , the graph $\mathcal{H}(\Lambda)$ has $r_p N_p$ additional Type 2 vertices, all of valence 2, which we label so that

$$V_2(\mathcal{H}(\Lambda)) = \{y_0\} \cup \{y_{pq}^j \mid 1 \leq p \leq M, 1 \leq q \leq N_p, 1 \leq j \leq r_p\}.$$

Each of the vertices y_{pq}^j is adjacent to both x_{pq}^+ and x_{pq}^- .

Similarly, $\mathcal{H}(\Lambda')$ has $2 \sum_{p=1}^M N'_p$ vertices of Type 1, given by

$$V_1(\mathcal{H}(\Lambda')) = \{x_{pq'}^+, x_{pq'}^- \mid 1 \leq p \leq M, 1 \leq q' \leq N'_p\},$$

and $1 + \sum_{p=1}^M r_p N'_p$ vertices of Type 2, given by

$$V_2(\mathcal{H}(\Lambda')) = \{y'_0\} \cup \{y'_{pq'}^j \mid 1 \leq p \leq M, 1 \leq q' \leq N'_p, 1 \leq j \leq r_p\},$$

so that y'_0 is adjacent to every Type 1 vertex, and $y'_{pq'}^j$ is adjacent to $x_{pq'}^+$ and $x_{pq'}^-$.

7.1.2. Constants. We next define quite a few constants for use in the proof of Proposition 7.1, continuing notation from Section 7.1.1. We will need the following lemma.

Lemma 7.2. *For each $1 \leq p \leq M$,*

$$\chi(W_{A'}) \cdot \left(\sum_{q=1}^{N_p} R_{pq} \right) = \chi(W_A) \cdot \left(\sum_{q'=1}^{N'_p} R'_{pq'} \right).$$

Proof. For any vector v , write \bar{v} for the sum of the entries of v . Using this and the notation of Theorem 1.12, an easy calculation shows that for each $i \in I$ and each $k \in I'$,

$$\chi(W_{\Theta_i}) = \sum_{j=1}^{r_i} \chi(W_{\beta_{ij}}) = \bar{v}_i \quad \text{and} \quad \chi(W_{\Theta'_k}) = \sum_{l=1}^{r'_k} \chi(W_{\beta_{kl}}) = \bar{v}'_k.$$

Now combining this with the notation established in Section 7.1.1, we have by condition (1)(b) of Theorem 1.12 that for each $1 \leq p \leq M$,

$$\chi(W_{A'}) \cdot \left(\sum_{q=1}^{N_p} \bar{v}_{pq} \right) = \chi(W_{A'}) \cdot \left(\sum_{q=1}^{N_p} R_{pq} \bar{w}_p \right) = \chi(W_A) \cdot \left(\sum_{q'=1}^{N'_p} R'_{pq'} \bar{w}_p \right) = \chi(W_A) \cdot \left(\sum_{q'=1}^{N'_p} \bar{v}'_{pq'} \right).$$

The result follows. \square

Next, for each $1 \leq p \leq M$, each $1 \leq q \leq N_p$, and each $1 \leq q' \leq N'_p$, let

$$(7.1) \quad k_{pq} = 16|R_{pq}| \quad \text{and} \quad k'_{pq'} = 16|R'_{pq'}|.$$

Then by Lemma 7.2, we may define constants B_p for $1 \leq p \leq M$ by

$$B_p = |\chi(\mathcal{A}')| \cdot \left(\sum_{q=1}^{N_p} k_{pq} \right) = |\chi(\mathcal{A})| \cdot \left(\sum_{q'=1}^{N'_p} k'_{pq'} \right).$$

We also define

$$(7.2) \quad B = \sum_{p=1}^M B_p.$$

Lemma 7.3. *Each k_{pq} and $k'_{pq'}$ is a positive integer divisible by 4. Each B_p is a positive integer, so B is a positive integer. For each p , we have $B_p \geq N_p$.*

Proof. As Γ and Γ' are triangle-free, the entries in the Euler characteristic vectors v_{pq} and $v'_{pq'}$, and the rationals $\chi(W_A)$ and $\chi(W_{A'})$, all have denominator at most 4. Now w_p has integer entries, by definition, so the rationals R_{pq} and $R'_{pq'}$ have denominator at most 4. The lemma follows easily from this. \square

We now define K to be the product of all of the k_{pq} and $k'_{pq'}$, that is,

$$(7.3) \quad K = \prod_{p=1}^M \left[\left(\prod_{q=1}^{N_p} k_{pq} \right) \left(\prod_{q'=1}^{N'_p} k'_{pq'} \right) \right].$$

We also define

$$(7.4) \quad d_{pq} = \frac{K}{k_{pq}}, \quad d'_{pq'} = \frac{K}{k'_{pq'}}, \quad D = K|\chi(W_{A'})|, \quad \text{and} \quad D' = K|\chi(W_A)|.$$

Lemma 7.3 now implies:

Lemma 7.4. *The constants K , d_{pq} , $d'_{pq'}$, D , and D' are all positive integers.* \square

7.1.3. *Construction of the half-covers Ψ and Ψ' .* We now construct the graphs Ψ and Ψ' , and show that they are isomorphic.

Let B be as defined at (7.2) above, and recall from Lemma 7.3 that B is a positive integer. The graphs Ψ and Ψ' will both have $2B$ Type 1 vertices. In Ψ , we use that $B = \sum_{p=1}^M \left(\sum_{q=1}^{N_p} |\chi(W_{A'})| k_{pq} \right)$ to put

$$V_1(\Psi) = \{x_{pq}^{i,+}, x_{pq}^{i,-} \mid 1 \leq p \leq M, 1 \leq q \leq N_p, 1 \leq i \leq |\chi(W_{A'})| k_{pq}\}.$$

In Ψ' , we use that $B = \sum_{p=1}^M \left(\sum_{q'=1}^{N'_p} |\chi(W_A)| k'_{pq'} \right)$ to put

$$V_1(\Psi') = \{x_{pq'}^{i',+}, x_{pq'}^{i',-} \mid 1 \leq p \leq M, 1 \leq q' \leq N'_p, 1 \leq i' \leq |\chi(W_A)| k'_{pq'}\}.$$

We now describe the Type 2 vertices of Ψ and Ψ' , and the edges. The graph Ψ has a distinguished Type 2 vertex y_1 of valence $2B$, which is adjacent to every Type 1 vertex. There are $\sum_{p=1}^M B_p r_p$ additional Type 2 vertices in Ψ , each of valence 2, so that:

$$V_2(\Psi) = \{y_1\} \cup \{y_{pq}^{ij} \mid 1 \leq p \leq M, 1 \leq q \leq N_p, 1 \leq i \leq |\chi(W_{A'})| k_{pq}, 1 \leq j \leq r_p\}.$$

For $1 \leq j \leq r_p$, the vertex y_{pq}^{ij} is adjacent to $x_{pq}^{i,+}$ and $x_{pq}^{i,-}$. Similarly, the graph Ψ' has $1 + \sum_{p=1}^M B_p r_p$ Type 2 vertices, given by

$$V_2(\Psi') = \{y_1'\} \cup \{y_{pq'}^{i'j} \mid 1 \leq p \leq M, 1 \leq q' \leq N'_p, 1 \leq i' \leq |\chi(W_A)| k'_{pq'}, 1 \leq j \leq r_p\},$$

with y_1' adjacent to every Type 1 vertex, and $y_{pq'}^{i'j}$ adjacent to $x_{pq'}^{i',+}$ and $x_{pq'}^{i',-}$.

Lemma 7.5. *The graphs Ψ and Ψ' are isomorphic.*

Proof. By construction, it suffices to show that for each p , the B_p vertices $\{x_{pq}^{i,+} \mid 1 \leq q \leq N_p, 1 \leq i \leq |\chi(W_{A'})| k_{pq}\}$ in Ψ and the B_p vertices $\{x_{pq'}^{i',+} \mid 1 \leq q' \leq N'_p, 1 \leq i' \leq |\chi(W_A)| k'_{pq'}\}$ in Ψ' have the same collection of valences. But each of these vertices in fact has the same valence, namely $1 + r_p$, since each $x_{pq}^{i,+}$ (respectively, $x_{pq'}^{i',+}$) is adjacent to the central vertex y_1 (respectively, y_1'), and to the r_p vertices $\{y_{pq}^{ij} \mid 1 \leq j \leq r_p\}$ (respectively, $\{y_{pq'}^{i'j} \mid 1 \leq j \leq r_p\}$). The result follows. \square

The next lemma is easily verified.

Lemma 7.6. *There is a half-covering $\Psi \rightarrow \mathcal{H}(\Lambda)$ induced by $y_1 \mapsto y_0$, $x_{pq}^{i,\pm} \mapsto x_{pq}^\pm$, and $y_{pq}^{ij} \mapsto y_{pq}^j$, and similarly for $\Psi' \rightarrow \mathcal{H}(\Lambda')$.*

7.1.4. *Covering the central surfaces.* Denote by S_A the surface in \mathcal{X} that covers the orbifold \mathcal{A} with degree 16, and by $S_{A'}$ the corresponding surface in \mathcal{X}' (see Section 4.3 for the constructions of these surfaces). In this section, we construct a common cover T of the surfaces S_A and $S_{A'}$.

Recall that the boundary components of S_A (respectively, $S_{A'}$) are in bijection with the Type 1 vertices of $\mathcal{H}(\Lambda)$ (respectively, $\mathcal{H}(\Lambda')$). Now label the boundary components of S_A and $S_{A'}$ using the notation for the Type 1 vertices of these graphs from Section 7.1.1 above. Let d_{pq} , $d_{pq'}$, D , and D' be the positive integers defined at (7.4) above.

Lemma 7.7. *There exists a connected surface T with $2B$ boundary components which covers S_A with degree D and $S_{A'}$ with degree D' .*

Proof. Notice first that

$$D \cdot \chi(S_A) = (K|\chi(W_{A'})|) \cdot (16\chi(W_A)) = (K|\chi(W_A)|) \cdot (16\chi(W_{A'})) = D' \cdot \chi(S_{A'}),$$

so these covering degrees are compatible with the existence of T .

Next we consider the number of boundary components. Recall from Section 4.3 that S_A is obtained by gluing together the connected surface S_A , which has $2N$ boundary components, and a connected surface S_β with two boundary components for every branch β in Γ whose vertices are contained in A . There is one such S_β for every $r_i = 1$, thus S_A has two boundary components for every $r_i \geq 2$. Hence S_A has $2 \sum_{p=1}^M N_p$ boundary components. Similarly, $S_{A'}$ has $2 \sum_{p=1}^M N'_p$ boundary components.

Now by Lemma 7.3, we have $B_p \geq N_p$ (respectively, $B_p \geq N'_p$) for $1 \leq p \leq M$. Since $B = \sum_{p=1}^M B_p$, it follows that the number of boundary components of S_A (respectively, $S_{A'}$) has the same parity as $2B$, and is less than or equal to $2B$.

Now let T be a connected surface with Euler characteristic $\chi(T) = D \cdot \chi(S_A) = D' \cdot \chi(S_{A'})$ and $2B$ boundary components. To complete the proof, by Lemma 2.12 it suffices to specify the degrees by which the boundary components of T will cover the boundary components of S_A and $S_{A'}$.

For this, we label the $2B$ boundary components of T in two different ways, first by the Type 1 vertices of Ψ , and second by the Type 1 vertices of Ψ' (see Section 7.1.3 above). We specify that for $1 \leq i \leq |\chi(W_{A'})|k_{pq}$, the boundary component $x_{pq}^{i,+}$ of T covers the boundary component x_{pq}^+ of S_A with degree $d_{pq} = K/k_{pq}$, and that for $1 \leq i' \leq |\chi(W_A)|k'_{pq'}$, the boundary component $x_{pq'}^{i',+}$ of T covers the boundary component $x_{pq'}^+$ of $S_{A'}$ with degree $d'_{pq'} = K/k'_{pq'}$. Hence the union $\cup_i x_{pq}^{i,+}$ covers x_{pq}^+ with total degree $|\chi(W_{A'})|k_{pq}d_{pq} = |\chi(W_{A'})|K = D$ and the union $\cup_{i'} x_{pq'}^{i',+}$ covers $x_{pq'}^+$ with total degree $|\chi(W_A)|k'_{pq'}d'_{pq'} = |\chi(W_A)|K = D'$. Similarly, the union $\cup_i x_{pq}^{i,-}$ covers $x_{pq}^- \subset S_A$ with degree D in total and degree d_{pq} on each component, and $\cup_{i'} x_{pq'}^{i',-} \subset T$ covers $x_{pq'}^- \subset S_{A'}$ with degree D' in total and degree $d'_{pq'}$ on each component. This completes the proof. \square

7.1.5. *Covering the other surfaces.* For each p, q, q' , and j , let S_{pq}^j (respectively, $S_{pq'}^j$) be the surface in \mathcal{X} (respectively, \mathcal{X}') corresponding to the vertex $y_{pq}^j \in V_2(\mathcal{H}(\Lambda))$ (respectively, $y_{pq'}^j \in V_2(\mathcal{H}(\Lambda'))$). Recall that each S_{pq}^j and $S_{pq'}^j$ has 2 boundary components. In this section we construct a surface T_p^j which is a common cover of the surfaces S_{pq}^j and $S_{pq'}^j$.

Lemma 7.8. *For each $1 \leq p \leq M$ and each $1 \leq j \leq r_p$, there exists a connected surface T_p^j with 2 boundary components so that:*

- (1) for all $1 \leq q \leq N_p$, the surface T_p^j covers S_{pq}^j with degree d_{pq} in total, and degree d_{pq} on each boundary component; and
- (2) for all $1 \leq q' \leq N'_p$, the surface T_p^j covers $S_{pq'}^j$ with degree $d'_{pq'}$ in total, and degree $d'_{pq'}$ on each boundary component.

The constants d_{pq} and $d'_{pq'}$ in this statement are as defined at (7.4) above.

Proof. We prove (1); the proof of (2) is similar. Write w_p^j and v_{pq}^j for the j th entry of the vectors w_p and v_{pq} , respectively. Let T_p^j be a connected surface with 2 boundary components and Euler characteristic $\chi(T_p^j) = -Kw_p^j$, where K is the positive integer defined at (7.3) above. Since each S_{pq}^j also has 2 boundary components, by Lemma 2.12 it suffices to show that $\chi(T_p^j) = d_{pq}\chi(S_{pq}^j)$. Now S_{pq}^j is a 16-fold cover of an orbifold with Euler characteristic v_{pq}^j , so

$$d_{pq}\chi(S_{pq}^j) = 16d_{pq}v_{pq}^j = 16d_{pq}R_{pq}w_p^j = -k_{pq}d_{pq}w_p^j = -Kw_p^j = \chi(T_p^j)$$

where the constant k_{pq} is as defined at (7.1) above. This completes the proof. \square

7.1.6. *Constructions of surface amalgams \mathcal{Y} and \mathcal{Y}' .* We finish the proof of Proposition 7.1 by constructing homeomorphic surface amalgams \mathcal{Y} and \mathcal{Y}' which cover \mathcal{X} and \mathcal{X}' , respectively.

Recall that the surface amalgam \mathcal{Y} will have JSJ graph Ψ , and \mathcal{Y}' will have JSJ graph Ψ' , where Ψ and Ψ' are the isomorphic graphs from Section 7.1.3 above. The surfaces in \mathcal{Y} and \mathcal{Y}' will be those constructed in Sections 7.1.4 and 7.1.5 above, as we now explain. In \mathcal{Y} , put $S_{y_1} = T$, and in \mathcal{Y}' , put $S_{y'_1} = T$, where T is the surface with $2B$ boundary components from Lemma 7.7. Now for each p, q, q', i, i' , and j , if $y = y_{pq}^{ij} \in V_2(\Psi)$ write S_{pq}^{ij} for the surface S_y in \mathcal{Y} , and similarly, if $y' = y_{pq'}^{i'j} \in V_2(\Psi')$ write $S_{pq'}^{i'j}$ for the surface $S_{y'}$ in \mathcal{Y}' . We then put $S_{pq}^{ij} = T_p^j$ in \mathcal{Y} and $S_{pq'}^{i'j} = T_p^j$ in \mathcal{Y}' , where T_p^j is the surface with 2 boundary components constructed in Lemma 7.8 above.

To glue these surfaces together to form a surface amalgam \mathcal{Y} which covers \mathcal{X} , we label the two boundary components of S_{pq}^{ij} by the two vertices of Ψ which are adjacent to y_{pq}^{ij} , namely $x_{pq}^{i,+}$ and $x_{pq}^{i,-}$. Now recall from the proof of Lemma 7.7 that if we label the boundary components of $T = S_{y_1}$ by the Type 1 vertices of Ψ , then the boundary component $x_{pq}^{i,\pm}$ of S_{y_1} covers the boundary component x_{pq}^{\pm} of $S_{\mathcal{A}} \subset \mathcal{X}$ with degree d_{pq} . Also, by Lemma 7.8, the covering from $T_p^j = S_{pq}^{ij}$ to the surface $S_{pq}^j \subset \mathcal{X}$ has degree d_{pq} on each boundary component. Since the degrees of these coverings $S_{y_1} \rightarrow S_{\mathcal{A}}$ and $S_{pq}^{ij} \rightarrow S_{pq}^j$ are equal on each boundary component which has the same label, we may glue together boundary components of the collection $\{S_{y_1}\} \cup \{S_{pq}^{ij}\}$ which have the same labels to obtain a surface amalgam \mathcal{Y} which covers \mathcal{X} . The construction of \mathcal{Y}' which covers \mathcal{X}' is similar.

Now all of the surfaces in \mathcal{Y} and \mathcal{Y}' are compact, hence the coverings $\mathcal{Y} \rightarrow \mathcal{X}$ and $\mathcal{Y}' \rightarrow \mathcal{X}'$ are finite-sheeted (in fact, they have degrees D and D' respectively, but we will not need this). The following lemma then completes the proof of Proposition 7.1.

Lemma 7.9. *The surface amalgams \mathcal{Y} and \mathcal{Y}' are homeomorphic.*

Proof. We note first that \mathcal{Y} and \mathcal{Y}' have isomorphic JSJ graphs Ψ and Ψ' , by Lemma 7.5, so it suffices to consider the surfaces in \mathcal{Y} and \mathcal{Y}' . By construction, \mathcal{Y} and \mathcal{Y}' have the same central surface $S_{y_1} = T = S_{y'_1}$. Now for each $1 \leq p \leq M$, consider the $B_p r_p$ surfaces $\{S_{pq}^{ij}\}$ in \mathcal{Y} and the $B_p r_p$ surfaces $\{S_{pq'}^{i'j}\}$ in \mathcal{Y}' . Since $S_{pq}^{ij} = T_p^j = S_{pq'}^{i'j}$ for each q, q', i, i' , we have by construction that each of the B_p pairs of branching curves $\{x_{pq}^{i,+}, x_{pq}^{i,-}\}$ in \mathcal{Y} (respectively, $\{x_{pq'}^{i',+}, x_{pq'}^{i',-}\}$ in \mathcal{Y}') is incident to the same collection of $1+r_p$ surfaces $\{T\} \cup \{T_p^j\}$. Hence \mathcal{Y} and \mathcal{Y}' are homeomorphic. \square

This completes the proof of Proposition 7.1.

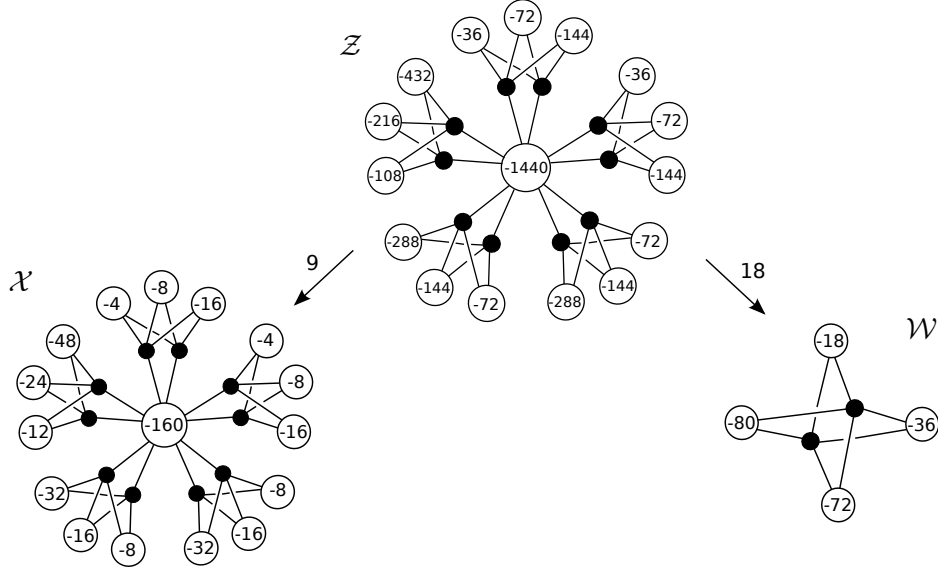

FIGURE 7.2. Illustrated above is an example of the covers described in Section 7.2, on the level of the JSJ graphs. The white vertices represent surfaces with specified Euler characteristic; the valence of the vertex is the number of boundary components of the surface. The black vertices represent branching curves that are glued to boundary components of adjacent surfaces. The covering maps between surface amalgams restrict to half-coverings between the JSJ graphs. In this example, the space \mathcal{X} does not cover the space \mathcal{W} , and there is no minimal surface amalgam within this commensurability class.

7.2. **Sufficiency of condition (2).** We now prove the following result.

Proposition 7.10. *Let $W = W_\Gamma$ and $W' = W_{\Gamma'}$ be as in Theorem 1.12. If condition (2) holds, then W and W' are commensurable.*

By the construction described in Section 4, there are surface amalgams \mathcal{X} and \mathcal{X}' which form degree 16 covers of the orbicomplexes \mathcal{O}_Γ and $\mathcal{O}_{\Gamma'}$, respectively. To prove that W and W' are abstractly commensurable, we prove there are finite-sheeted covers $\mathcal{Z} \rightarrow \mathcal{X}$ and $\mathcal{Z}' \rightarrow \mathcal{X}'$ and a surface amalgam \mathcal{W} so that \mathcal{Z} and \mathcal{Z}' finitely cover \mathcal{W} . An example of the construction given in this section appears in Figure 7.2.

We will describe these covering spaces and maps in terms of their JSJ graphs and half-covers as defined in Section 4.1. We set notation in Section 7.2.1. The surface amalgam \mathcal{W} is described in Section 7.2.2. The surface amalgam \mathcal{Z} and the finite cover $\mathcal{Z} \rightarrow \mathcal{X}$ is given in Section 7.2.3. Finally, the finite cover $\mathcal{Z} \rightarrow \mathcal{W}$ is given in Section 7.2.4. The construction for \mathcal{X}' is analogous.

7.2.1. *Notation.* For ease of notation, suppose the elements of the multiset of Euler characteristic vectors $\{v_i \mid i \in I\}$ in the statement of Theorem 1.12 are labeled v_1, \dots, v_n . By assumption, there exists $r \geq 2$ so that each vector v_i for $1 \leq i \leq n$ has r entries. Let \mathcal{V} denote the commensurability class of the vectors $\{v_i \mid 1 \leq i \leq n\}$.

The orbicomplex \mathcal{O}_Γ contains a central orbifold \mathcal{A} with n non-reflection edges e_1, \dots, e_n . Attached to the non-reflection edge e_i is a collection of r branch orbifolds $\mathcal{P}_{i1}, \dots, \mathcal{P}_{ir}$, with $\mathcal{P}_{ij} = \mathcal{P}_{\beta_{ij}}$ and $\pi_1(\mathcal{P}_{ij}) = W_{ij} = W_{\beta_{ij}}$ for each $1 \leq i \leq n$ and $1 \leq j \leq r$. By definition, for $1 \leq i \leq n$ the Euler

characteristic vector v_i is given by

$$v_i = (\chi_{i1}, \dots, \chi_{ir}) = (\chi(W_{i1}), \dots, \chi(W_{ir})),$$

and w is the reordering of

$$\left(\sum_{j=1}^n \chi_{j1}, \sum_{j=1}^n \chi_{j2}, \dots, \sum_{j=1}^n \chi_{jr}, \chi(W_A) \right)$$

so that its entries are in non-increasing order.

The surface amalgam \mathcal{X} has a central surface $S_{\mathcal{A}}$ with Euler characteristic $16\chi(W_A)$ and $2n$ boundary components. Attached to each of the n pairs of boundary components of $S_{\mathcal{A}}$ are surfaces S_{i1}, \dots, S_{ir} for $1 \leq i \leq n$ where each S_{ij} has two boundary components and Euler characteristic $16\chi(W_{ij})$, and forms a degree 16 cover of \mathcal{P}_{ij} .

Let Λ be the JSJ graph of W . As described in Section 4.4, the JSJ graph of \mathcal{X} is the half-cover $\mathcal{H}(\Lambda)$. The graph $\mathcal{H}(\Lambda)$ has $2n$ vertices of Type 1. Label these vertices as

$$V_1(\mathcal{H}(\Lambda)) = \{x_i^+, x_i^- \mid 1 \leq i \leq n\}.$$

There is a central vertex of Type 2 associated to the surface $S_{\mathcal{A}}$; label this vertex as y_0 . This vertex is adjacent to every Type 1 vertex, hence has valence $2n$. For each i , the graph $\mathcal{H}(\Lambda)$ has r additional Type 2 vertices, associated to the surfaces S_{ij} for $1 \leq j \leq r$. Label these vertices accordingly, so that

$$V_2(\mathcal{H}(\Lambda)) = \{y_0\} \cup \{y_{ij} \mid 1 \leq i \leq n, 1 \leq j \leq r\}.$$

Each vertex y_{ij} is adjacent to x_i^+ and x_i^- .

For $1 \leq i \leq n$, define

$$\tilde{v}_i = 16v_i = (\chi(S_{i1}), \dots, \chi(S_{ir})) \in 2\mathbb{Z}_{<0}^r.$$

Let $\tilde{w} = 16w$, so that \tilde{w} is the reordering of

$$\left(\sum_{j=1}^n \chi(S_{j1}), \sum_{j=1}^n \chi(S_{j2}), \dots, \sum_{j=1}^n \chi(S_{jr}), \chi(S_{\mathcal{A}}) \right) \in 2\mathbb{Z}_{<0}^{r+1}$$

so that its entries are in non-increasing order. Suppose that in this ordering, $\chi(S_{\mathcal{A}})$ is the k^{th} entry of \tilde{w} . Let $\hat{w} \in \mathbb{Z}^r$ be the vector \tilde{w} with the k^{th} entry deleted. Then

$$\hat{w} = \tilde{v}_1 + \dots + \tilde{v}_n \in 2\mathbb{Z}_{<0}^r.$$

By condition (2)(b) in Theorem 1.12, the vectors w and w' are commensurable. Let

$$w_0 = (w_1, \dots, w_{r+1}) \in \mathbb{Z}^{r+1}$$

be the minimal integral element in the commensurability class of w and w' . Since all entries of w and w' are negative, all entries of w_0 are positive. Finally, let \widehat{w}_0 be the vector w_0 minus the k^{th} entry, so

$$\widehat{w}_0 = (w_1, \dots, w_{k-1}, w_{k+1}, \dots, w_{r+1}) \in \mathbb{Z}^r.$$

7.2.2. *The surface amalgam \mathcal{W} .* The surface amalgam \mathcal{W} has JSJ graph Φ with two Type 1 vertices labeled

$$V_1(\Phi) = \{x^+, x^-\}.$$

The graph Φ has $r + 1$ Type 2 vertices labeled

$$V_2(\Phi) = \{y_1, \dots, y_{r+1}\}.$$

Each Type 2 vertex is adjacent to both x^+ and x^- .

To construct the surface amalgam \mathcal{W} , for $1 \leq i \leq r + 1$, let W_i be the surface with Euler characteristic $-2w_i$ and 2 boundary components C_{i1} and C_{i2} ; the surface W_i is associated to the vertex y_i . Identify the curves C_{i1} for $1 \leq i \leq r + 1$ to create a single curve C_1 associated to the vertex x^+ , and identify the curves C_{i2} for $1 \leq i \leq r + 1$ to create a single curve C_2 associated to the vertex x^- . This forms a surface amalgam \mathcal{W} which has two singular curves C_1 and C_2 and JSJ graph Φ .

Lemma 7.11. *The graph $\mathcal{H}(\Lambda)$ forms a half-cover of the graph Φ .*

Proof. The cover is induced by the maps $x_i^+ \mapsto x^+$; $x_i^- \mapsto x^-$, $y_{ij} \mapsto y_j$ for $1 \leq i \leq n$ and $1 \leq j \leq r$, and $y_0 \mapsto y_{r+1}$. \square

Remark 7.12. In view of Lemma 7.11, note that \mathcal{X} does not necessarily finitely cover \mathcal{W} ; an example of this is given in Figure 7.2. To resolve this, we construct a finite cover $\mathcal{Z} \rightarrow \mathcal{X}$ so that \mathcal{Z} has JSJ graph $\mathcal{H}(\Lambda)$ and finitely covers \mathcal{W} .

7.2.3. *The surface amalgam \mathcal{Z} and the finite covering map $\mathcal{Z} \rightarrow \mathcal{X}$.* We will need the following lemma.

Lemma 7.13. *Let $u \in \mathbb{Z}^r$ be the minimal integral element in the commensurability class \mathcal{V} . There exists a positive integer K so that $\widehat{w}_0 = Ku$.*

Proof. Since $\tilde{v}_i = 16v_i$, the set of integer vectors $\{\tilde{v}_i, \widehat{w}, \widehat{w}_0 \mid 1 \leq i \leq n\}$ is also contained in \mathcal{V} . Thus there exists an integer K so that $\widehat{w}_0 = Ku$. Since all entries of \widehat{w}_0 and u are positive, K is a positive integer. \square

Let \mathcal{Z} be the following surface amalgam with JSJ graph $\mathcal{H}(\Lambda)$. Associated to the Type 2 vertex y_0 of $\mathcal{H}(\Lambda)$, the space \mathcal{Z} contains one central surface $\widetilde{S}_{\mathcal{A}}$ with $2n$ boundary components and Euler characteristic $\chi(\widetilde{S}_{\mathcal{A}}) = K\chi(S_{\mathcal{A}})$. Attached to the i^{th} pair of boundary curves of $\widetilde{S}_{\mathcal{A}}$, which are associated to the vertices $x_i^+, x_i^- \in \mathcal{H}(\Lambda)$ for $1 \leq i \leq n$, there are r surfaces \widetilde{S}_{ij} for $1 \leq j \leq r$, where \widetilde{S}_{ij} has 2 boundary components and Euler characteristic $K\chi(S_{ij})$; these surfaces are associated to the vertices y_{ij} in $\mathcal{H}(\Lambda)$.

Lemma 7.14. *The surface amalgam \mathcal{Z} forms a degree K cover of the surface amalgam \mathcal{X} , where K is the positive integer guaranteed by Lemma 7.13.*

Proof. By Lemma 2.12, the surface $\widetilde{S}_{\mathcal{A}}$ forms a degree K cover of the surface $S_{\mathcal{A}}$ so that the degree restricted to each boundary component of $\widetilde{S}_{\mathcal{A}}$ over the corresponding boundary component of $S_{\mathcal{A}}$ is equal to K . Similarly, by Lemma 2.12, each surface \widetilde{S}_{ij} forms a degree K cover of S_{ij} so that the degree restricted to each boundary component of \widetilde{S}_{ij} over the corresponding boundary component of S_{ij} is equal to K . Thus, since the covering maps agree along the gluings, \mathcal{Z} forms a degree K cover of \mathcal{X} . \square

7.2.4. *The finite cover $\mathcal{Z} \rightarrow \mathcal{W}$.* For $1 \leq i \leq n$, define

$$z_i = K\tilde{v}_i = (\chi(\tilde{S}_{i1}), \dots, \chi(\tilde{S}_{ij})) \text{ and } z = K\tilde{w},$$

where K is the positive integer from Lemma 7.13. Note that the entries of z are in non-increasing order. If $\chi(\tilde{S}_A)$ is the k^{th} entry of z , let \hat{z} be the vector z with the k^{th} entry deleted. Then

$$\hat{z} = K\hat{w} = z_1 + \dots + z_n \in 2\mathbb{Z}_{<0}^r.$$

Since w_0 is the minimal integral element in the commensurability class of $\tilde{w} \in 2\mathbb{Z}_{<0}^{r+1}$, there exists a positive integer M so that $\tilde{w} = -2Mw_0$. Hence, $z = MK(-2w_0)$. Let $D = MK \in \mathbb{N}$. Then

$$z = D(-2w_0) \text{ and } \hat{z} = D(-2\hat{w}_0).$$

We compute D a second way, and use this to prove that \mathcal{Z} finitely covers \mathcal{W} .

Lemma 7.15. *Let d_i be positive integers so that $\tilde{v}_i = d_i(-2u)$, where u is the minimal integral element in the commensurability class \mathcal{V} . Then $D = \sum_{i=1}^n d_i$.*

Proof. By construction of the covering map and the definition of K , we have

$$z_i = K\tilde{v}_i = K(d_i(-2u)) = d_i(-2\hat{w}_0).$$

Hence

$$\hat{z} = z_1 + \dots + z_n = \left(\sum_{i=1}^n d_i \right) (-2\hat{w}_0).$$

So, combining the two equations for \hat{z} given above, we have that $\sum_{i=1}^n d_i = D$. \square

Lemma 7.16. *The surface amalgam \mathcal{Z} forms a degree D cover of the surface amalgam \mathcal{W} .*

Proof. Suppose for ease of notation that $\chi(\tilde{S}_A)$ is the $(r+1)^{\text{st}}$ entry of the vector z . Then for all $1 \leq i \leq n$ and all $1 \leq j \leq r$, we have that $\chi(\tilde{S}_{ij}) = d_i\chi(W_j)$, where the surface W_j in \mathcal{W} has Euler characteristic w_j by definition, and d_i is defined in Lemma 7.15. By Lemma 2.12, \tilde{S}_{ij} covers W_j by degree d_i so that the degree restricted to each of the boundary components is equal to d_i . So, $\bigcup_{i=1}^n \tilde{S}_{ij}$ forms a degree D cover of W_j for all $1 \leq j \leq r$. In addition, $\chi(\tilde{S}_A) = D\chi(W_{r+1})$, and the n pairs of boundary components of \tilde{S}_A can be partitioned so that the i^{th} pair of boundary curves of \tilde{S}_A covers the pair of boundary curves of W_{r+1} by degree d_i , for $1 \leq i \leq n$, with $\sum_{i=1}^n d_i = D$. Thus by Lemma 2.12, the space \mathcal{Z} forms a D -fold cover of \mathcal{W} , concluding the proof. \square

8. GEOMETRIC AMALGAMS AND RACGS

In this section we further investigate the relationship between geometric amalgams of free groups and right-angled Coxeter groups. In Section 8.1 we prove Theorem 1.16 from the introduction, which states that the fundamental groups of surface amalgams whose JSJ graphs are trees are commensurable to right-angled Coxeter groups (with defining graphs in \mathcal{G}). As a consequence, we obtain the commensurability classification of geometric amalgams of free groups whose JSJ graphs are trees of diameter at most four (Corollary 1.17). Then in Section 8.2 we give an example of a geometric amalgam of free groups which is not commensurable to any Coxeter group, or indeed to any group which is finitely generated by torsion elements.

8.1. Geometric amalgams over trees. Suppose Γ is a graph satisfying Assumptions 1.1 and 1.2. Then the JSJ graph of W_Γ is a tree T , and we constructed (in Section 4) a geometric amalgam of free groups which is an index 16 subgroup of W_Γ and whose JSJ graph $\mathcal{H}(T)$ is as described in Definition 4.2. We begin by showing in Lemma 8.1 that under certain assumptions, a geometric amalgam of free groups whose underlying graph is of the form $\mathcal{H}(T)$ for some tree T can be realized as an index 16 subgroup of a right-angled Coxeter group. We then use this result to prove Theorem 1.16.

Lemma 8.1. *Let $G = G(\Lambda)$ be a geometric amalgam of free groups such that $\Lambda = \mathcal{H}(T)$ for some tree T , and suppose that the following conditions are satisfied.*

- (1) *The tree T is bipartite with $V(T) = V_1 \sqcup V_2$ so that each vertex in V_2 has odd valence.*
- (2) *If $V(\Lambda) = V'_1 \sqcup V'_2$ is obtained from $V(T)$ as in Definition 4.2, then each vertex in V'_2 has vertex group the fundamental group of a surface with positive even genus.*
- (3) *Given any interior (i.e. non-terminal) vertex x in V_2 with valence $L \geq 2$ in T , if g is the genus of the surface $S_{x'}$ associated to the corresponding vertex $x' \in V'_2$, then $g \geq 3L - 1$.*

Then there exists a graph Γ satisfying Assumptions 1.1 and 1.2 such that the JSJ graph of W_Γ is T , and G is an index 16 subgroup of W_Γ .

Proof. The conditions in the statement of the lemma allow us to follow the procedure from Section 4 backwards to construct an orbicomplex $\mathcal{O} = \mathcal{O}_\Gamma$ as in Section 3.3 as a graph of spaces with underlying graph T . Let $\mathcal{X} = \mathcal{X}(\Lambda)$ be the surface amalgam with fundamental group G as described in Section 2.3. For each vertex in $V_1 \subset V(T)$ the associated vertex space of \mathcal{O} will be an edge of length 1, and for each vertex in $V_2 \subset V(T)$, the associated vertex space of \mathcal{O} will be an orbifold determined as follows.

Let $x \in V_2$ be a terminal vertex. Then the associated vertex space of \mathcal{O} is the following orbifold $\mathcal{P}_x \subset \mathcal{O}$. The vertex x is half-covered by a vertex x' of valence 2 in $V'_2 \subset V(\Lambda)$, hence the surface $S_{x'}$ in \mathcal{X} has 2 boundary components. By condition (2), the surface $S_{x'}$ has positive even genus g . As described in Section 4, the surface $S_{x'}$ forms a degree 16 cover of \mathcal{P}_x , a branch orbifold (in the terminology of Section 3.1) with underlying space a right-angled hyperbolic polygon with $\frac{g}{2} + 4 \geq 5$ sides. The orbifold \mathcal{P}_x has $\frac{g}{2} + 3 \geq 4$ reflection edges and one non-reflection edge of length 1 which is identified to an edge vertex space of \mathcal{O} .

A non-terminal vertex $x \in V_2$ has associated vertex space the following orbifold $\mathcal{A}_x \subset \mathcal{O}$. By condition (1), the valence of x in T is L , an odd integer. The vertex x is half-covered by a vertex x' of valence $2L$ in Λ , so the surface $S_{x'}$ of \mathcal{X} has $2L$ boundary components. Moreover, by (2) and (3), the surface $S_{x'}$ has even genus g with $g \geq 3L - 1$. We will realize $S_{x'}$ as a cover of a non-branch orbifold \mathcal{A}_x (in the terminology of Section 3.2) so that the orbifold \mathcal{A}_x is the union of an essential vertex orbifold \mathcal{Q}_A and one branch orbifold \mathcal{P} , identified to each other along a non-reflection edge of each. To do this, decompose $S_{x'}$ into two surfaces S_1 and S_2 by cutting along a pair of non-separating curves whose union separates $S_{x'}$, and such that S_1 has $2L + 2$ boundary components and genus $3(L + 1) - 7 < g$, and S_2 has two boundary components and genus h satisfying $g = 1 + 3(L + 1) - 7 + h$. Thus $h = g - 3L + 3$. By the construction in Section 4, the surface S_1 can be realized as a degree 16 cover of a right-angled orbifold with underlying space a $2(L + 1)$ -gon \mathcal{Q}_A so that \mathcal{Q}_A has $L + 1$ reflection edges and $L + 1$ non-reflection edges each of length 1. The assumptions that g is even and L is odd imply that h is even, and the assumption that $g \geq 3L - 1$ implies that h is positive. Thus as before, the surface S_2 forms a degree 16 cover of a branch orbifold \mathcal{P} with $\frac{h}{2} + 4 \geq 5$ sides. The orbifold \mathcal{P} has $\frac{h}{2} + 3$ reflection edges and one non-reflection edge of length 1. Form the orbifold \mathcal{A}_x by gluing the non-reflection edge of \mathcal{P} to one of the non-reflection edges of \mathcal{Q}_A .

We now identify the orbifold vertex spaces just described according to the incidence relations of T to get an orbicomplex \mathcal{O} . Arguments similar to those from Section 3 show that the fundamental group of \mathcal{O} is a right-angled Coxeter group W_Γ . Since the covering maps from the surfaces in \mathcal{X} to the orbifolds in \mathcal{O} agree along their intersections, the space \mathcal{X} finitely covers \mathcal{O} , and the lemma follows. \square

We now prove Theorem 1.16 by showing that every geometric amalgam with underlying graph a tree is commensurable to a geometric amalgam satisfying the hypothesis of Lemma 8.1.

Proof of Theorem 1.16. Let $G(T)$ be a geometric amalgam of free groups with JSJ graph a tree T , and let $\mathcal{X} = \mathcal{X}(T)$ be the associated surface amalgam with fundamental group $G(T)$. Corollary 2.11 implies that by passing to an index 3 subgroup of G if necessary, we may assume that every surface in \mathcal{X} has positive genus.

Next, we show that there is a finite-index subgroup $G'(T')$ of $G(T)$, such that $G'(T')$ is a geometric amalgam of free groups over a tree T' in which each Type 2 vertex of T' has odd valence. If every Type 2 vertex of T is a terminal vertex, then every Type 2 vertex of T has valence 1, so we put $T' = T$ and $G'(T') = G(T)$. Otherwise, we construct $G'(T')$ as follows. Choose a terminal vertex x_0 of T . By definition x_0 is a Type 2 vertex of odd valence. Now let x_1, \dots, x_k be the Type 2 vertices at distance 2 from x_0 in T . Note that any Type 2 vertex is at an even distance from x_0 , and that by assumption on T , at least one of x_1, \dots, x_k has valence ≥ 2 . Let $S_0 = S_{x_0}$ be the surface in \mathcal{X} associated to x_0 , with one boundary component C , and for $1 \leq i \leq k$, let the surface $S_i = S_{x_i}$ have boundary curves C_{i1}, \dots, C_{in_i} , where the valence of x_i is n_i . We may assume that C_{i1} is glued to C in \mathcal{X} , for $1 \leq i \leq k$. By Lemma 2.12, there exist surfaces S_0^1, \dots, S_k^1 such that S_i^1 is a degree 2 cover of S_i for each $0 \leq i \leq k$, and the following conditions on boundaries hold: the surface S_0^1 has a single boundary curve C^1 which covers $C \subset S_0$ with degree 2, and for $1 \leq i \leq k$, the surface S_i^1 has $2n_i - 1$ boundary curves, $C_{i1}^1, C_{i2}^{1\pm}, \dots, C_{in_i}^{1\pm}$, such that C_{i1}^1 covers $C_{i1} \subset S_i$ with degree 2, and if $n_i \geq 2$, then each $C_{ij}^{1\pm}$ with $2 \leq j \leq n_i$ covers $C_{ij} \subset S_i$ with degree 1.

Using these degree 2 covering surfaces, we construct a 2-sheeted cover $\mathcal{X}_1 \rightarrow \mathcal{X}$ as follows. For $1 \leq i \leq k$ and all $n_i \geq 2$, consider the space obtained from \mathcal{X} by deleting the interior of S_i , and for $2 \leq j \leq n_i$ denote by X_{ij} the connected component of this space which contains the boundary curve $C_{ij} \subset S_i$. Now we glue together all of the surfaces S_i^1 , $0 \leq i \leq k$, by identifying the curves C^1 and C_{i1}^1 for all $1 \leq i \leq k$. Then, for each i such that $n_i \geq 2$ and $2 \leq j \leq n_i$, we attach a copy of X_{ij} to C_{ij}^{1+} along C_{ij} , and a copy of X_{ij} to C_{ij}^{1-} also along C_{ij} , to get the surface amalgam \mathcal{X}_1 . By construction, there is a degree 2 covering map from \mathcal{X}_1 to \mathcal{X} . Moreover, the underlying graph of \mathcal{X}_1 is a tree, say T_1 , and if x_0^1 denotes the vertex associated to S_0^1 in \mathcal{X}_1 then each Type 2 vertex of T_1 at distance at most 2 from x_0^1 in T_1 has odd valence.

Inductively repeat this procedure to get a sequence of surface amalgams $\mathcal{X}_2, \mathcal{X}_3, \dots$ with underlying graphs which are trees T_2, T_3, \dots , so that \mathcal{X}_i covers \mathcal{X}_{i-1} with degree 2, and if x_0^i denotes the vertex of T_i corresponding to x_0 , then each Type 2 vertex of T_i at distance at most $2i$ from x_0^i has odd valence. After finitely many steps, we obtain a surface amalgam $\mathcal{X}' = \mathcal{X}'(T')$ which finitely covers \mathcal{X} , such that each Type 2 vertex of T' has odd valence. The fundamental group of this space $G'(T')$ is a finite-index subgroup of $G(T)$.

By passing to a further cover \mathcal{X}'' of \mathcal{X}' using Lemma 2.12, we may assume that each non-terminal Type 2 vertex of $G'(T')$ satisfies condition (3) of Lemma 8.1.

Finally, construct a surface amalgam over the graph $\mathcal{H}(T')$ that forms a degree 4 cover of \mathcal{X}'' as follows. For each Type 2 vertex x of T' , take a degree 4 cover S'_x of the corresponding vertex space S_x , with twice as many boundary components as S_x , so that the boundary components come in pairs which map by degree 2 to a boundary component of S_x . The graph $\mathcal{H}(T')$ determines how to

glue these vertex spaces together. Since each Type 2 vertex of T' has odd valence, an elementary Euler characteristic calculation proves the surface S'_x has even genus. Hence, condition (2) of Lemma 8.1 is satisfied. Now, applying Lemma 8.1 to the geometric amalgam $G(\mathcal{H}(T'))$ determined by $\mathcal{H}(T')$, proves that $G(\mathcal{H}(T'))$, and therefore $G(T)$, is commensurable to a right-angled Coxeter group with JSJ graph T' . \square

Proof of Corollary 1.17. Consider an arbitrary tree with diameter at most 4. In this special setting, the procedure in the above proof yields a tree which still has diameter at most 4 and is such that each Type 2 vertex has odd valence. Then the commensurable right-angled Coxeter group W_Γ constructed in Lemma 8.1 has JSJ graph which is a tree with diameter at most 4. By Remark 2.6, the group W_Γ is therefore one whose defining graph is either a generalized Θ -graph or a cycle of generalized Θ -graphs. Corollary 1.17 follows. \square

8.2. Geometric amalgams not over trees. In the case of surface amalgams whose JSJ graphs are not trees, the situation is more complicated. Since $\mathcal{H}(T)$ is not a tree, clearly some geometric amalgams of free groups whose JSJ graphs are not trees are commensurable to right-angled Coxeter groups. On the other hand, the following example shows that there exist geometric amalgams of free groups which are not commensurable to any Coxeter group, or indeed any group which is finitely generated by torsion elements.

Example 8.2. Let G be a geometric amalgam of free groups with JSJ graph Λ as in Figure 8.1, where the Type 1 vertices are white and the Type 2 vertices black.

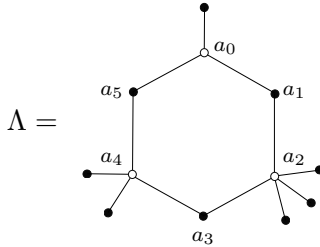

FIGURE 8.1.

Suppose G is commensurable (and so quasi-isometric) to a group H which is finitely generated by torsion elements. Then H is also 1-ended and hyperbolic, and G and H have the same JSJ tree \mathcal{T} . Moreover, the JSJ graph of H is a finite tree, say Ψ . (The graph Ψ is a tree since any group with a non-trivial loop in its JSJ graph admits a non-trivial homomorphism to \mathbb{Z} , but no such homomorphism from H to \mathbb{Z} exists.) Now the JSJ tree \mathcal{T} half-covers Ψ . We show that this is a contradiction, by showing that if $\theta : \mathcal{T} \rightarrow T$ is a half-covering, where T is any tree, then T must be infinite. In the following argument, all indices are taken mod 6.

For each vertex a_i of $\Lambda = G \setminus \mathcal{T}$, by abuse of notation write Ga_i for the G -orbit of some lift of a_i in \mathcal{T} . The following are straightforward consequences of the definition of a half-cover.

- (1) Each vertex in $\theta(Ga_i) \subset V(T)$ is adjacent to at least one vertex from each of $\theta(Ga_{i-1})$ and $\theta(Ga_{i+1})$.
- (2) For all $i \neq j$, we have $\theta(Ga_i) \cap \theta(Ga_j) = \emptyset$.

To show that T must be infinite, we define a map $\nu : [0, \infty) \rightarrow T$ as follows. Choose $\nu(0)$ to be an element of $\theta(Ga_0)$, and then for each $i > 0$, inductively choose $\nu(i)$ to be an element of $\theta(Ga_i)$ adjacent to $\theta(Ga_{i-1})$, which exists by (1) above. The adjacency condition can now be used to extend ν to $[0, \infty)$. By (2), we conclude that for each $i > 0$, the vertices $\nu(i-1)$ and $\nu(i+1)$

are distinct (i.e. there is no “folding”). This, together with the fact that T is a tree, implies that ν is injective, and it follows that T is infinite.

9. DISCUSSION

In this section we discuss some obstructions to extending our commensurability results.

A natural strategy that we considered is that used by Behrstock–Neumann in [1] for quasi-isometry classification. In Theorem 3.2 of [1], it is shown that two non-geometric graph manifolds M and M' which have isomorphic Bass–Serre trees T and T' are quasi-isometric, by first proving that there is a minimal graph Λ'' which is *weakly covered* by both of the quotient graphs $\Lambda = \pi_1(M)\backslash T$ and $\Lambda' = \pi_1(M')\backslash T'$. The notion of weak covering just requires the graph morphism to be locally surjective, unlike the half-coverings we introduce in Section 4.1, which must be locally bijective at vertices of Type 1. The minimal graph Λ'' determines a 3-manifold M'' which is covered by both M and M' , and a bilipschitz map $M \rightarrow M'$ is constructed by showing that there are bilipschitz maps $M \rightarrow M''$ and $M' \rightarrow M''$.

We now give an example to explain why such a strategy cannot be pursued in our setting. Let $G = G(\Lambda)$ and $G' = G(\Lambda')$ be geometric amalgams of free groups with JSJ graphs Λ and Λ' as shown in Figure 9.1, with Type 1 vertices white and Type 2 vertices black. Since all Type 1 vertices

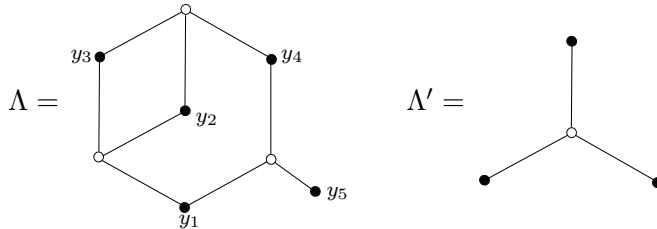

FIGURE 9.1.

in Λ and Λ' are of valence 3, the groups G and G' have isomorphic JSJ trees. Now the graph Λ' does not half-cover any other graph, so if any graph is half-covered by both Λ and Λ' , then there is a half-covering $\theta : \Lambda \rightarrow \Lambda'$. The map θ must send each of the triples of Type 2 vertices $\{y_1, y_2, y_3\}$, $\{y_2, y_3, y_4\}$, and $\{y_1, y_4, y_5\}$ of Λ to the three distinct Type 2 vertices of Λ' , but this is impossible. Hence there is no (minimal) graph which is half-covered by both Λ and Λ' .

Instead, we may approach commensurability by considering common finite half-covers of Λ and Λ' . More precisely, we consider common finite half-covers of finite, connected, bipartite graphs Λ and Λ' in which all Type 1 vertices have valence ≥ 3 , such that Λ and Λ' are both half-covered by the same (infinite) bipartite tree in which all Type 2 vertices have countably infinite valence. With these assumptions, any corresponding geometric amalgams of free groups $G = G(\Lambda)$ and $G' = G(\Lambda')$ will have isomorphic JSJ trees (a necessary condition for commensurability). Using similar methods to those of Leighton [17] (see also Neumann [20]), we can construct a common finite half-cover Λ'' of any two such graphs Λ and Λ' .

However, a half-covering of JSJ graphs does not necessarily induce a topological covering map of associated surface amalgams. For example, in Figure 7.2, the JSJ graph of $\pi_1(\mathcal{X})$ does half-cover the JSJ graph of $\pi_1(\mathcal{W})$, but by considering Euler characteristics, one sees that the surface amalgam \mathcal{X} does not cover the surface amalgam \mathcal{W} . Hence half-coverings of graphs may not induce finite-index embeddings of associated geometric amalgams of free groups. Indeed, our results distinguishing commensurability classes can be used to construct examples where for certain surface amalgams \mathcal{X} over Λ and \mathcal{X}' over Λ' , there is no surface amalgam \mathcal{X}'' over a common finite half-cover Λ'' so that \mathcal{X}'' covers both \mathcal{X} and \mathcal{X}' . Such examples exist even when Λ and Λ' are isomorphic graphs.

A priori, we see no reason why there would be a bound on the size of common half-covers so that in determining whether two groups are commensurable, it is enough to look at the set of common half-covers of their JSJ graphs up to a given size and determine whether suitable surface amalgams over these graphs exist.

Finally we remark that the proofs of our necessary and sufficient conditions for cycles of generalized Θ -graphs make substantial use of Λ and Λ' both having a distinguishable central vertex, so it is not clear how to generalize the commensurability classification to arbitrary pairs of JSJ graphs.

REFERENCES

- [1] Jason A. Behrstock and Walter D. Neumann. Quasi-isometric classification of graph manifold groups. *Duke Math. J.*, 141(2):217–240, 2008.
- [2] Riccardo Benedetti and Carlo Petronio. *Lectures on hyperbolic geometry*. Universitext. Springer-Verlag, Berlin, 1992.
- [3] Brian H. Bowditch. Cut points and canonical splittings of hyperbolic groups. *Acta Math.*, 180(2):145–186, 1998.
- [4] Martin R. Bridson and André Haefliger. *Metric spaces of non-positive curvature*, volume 319 of *Grundlehren der Mathematischen Wissenschaften [Fundamental Principles of Mathematical Sciences]*. Springer-Verlag, Berlin, 1999.
- [5] John Crisp. Automorphisms and abstract commensurators of 2-dimensional Artin groups. *Geom. Topol.*, 9:1381–1441, 2005.
- [6] John Crisp and Luisa Paoluzzi. Commensurability classification of a family of right-angled Coxeter groups. *Proc. Amer. Math. Soc.*, 136(7):2343–2349, 2008.
- [7] Pallavi Dani and Anne Thomas. Bowditch’s JSJ tree and the quasi-isometry classification of certain Coxeter groups. arxiv:1402.6224.
- [8] Michael W. Davis. *The geometry and topology of Coxeter groups*, volume 32 of *London Mathematical Society Monographs Series*. Princeton University Press, Princeton, NJ, 2008.
- [9] Allan L. Edmonds, Ravi S. Kulkarni, and Robert E. Stong. Realizability of branched coverings of surfaces. *Trans. Amer. Math. Soc.*, 282(2):773–790, 1984.
- [10] David Futer and Anne Thomas. Surface quotients of hyperbolic buildings. *Int. Math. Res. Not. IMRN*, (2):437–477, 2012.
- [11] Rafael Guglielmetti, Matthieu Jacquemet, and Ruth Kellerhals. On commensurable hyperbolic Coxeter groups. *Geom. Dedicata*, 183:143–167, 2016.
- [12] Jingyin Huang. Commensurability of groups quasi-isometric to RAAG’s. arxiv:1603.08586.
- [13] Jingyin Huang. Quasi-isometry rigidity of right-angled Artin groups I: the finite out case. arxiv:1410.8512.
- [14] N. W. Johnson, R. Kellerhals, J. G. Ratcliffe, and S. T. Tschantz. Commensurability classes of hyperbolic Coxeter groups. *Linear Algebra Appl.*, 345:119–147, 2002.
- [15] Michael Kapovich. *Hyperbolic manifolds and discrete groups*. Modern Birkhäuser Classics. Birkhäuser Boston, Inc., Boston, MA, 2009. Reprint of the 2001 edition.
- [16] Jean-François Lafont. Diagram rigidity for geometric amalgamations of free groups. *J. Pure Appl. Algebra*, 209(3):771–780, 2007.
- [17] Frank Thomson Leighton. Finite common coverings of graphs. *J. Combin. Theory Ser. B*, 33(3):231–238, 1982.
- [18] William Malone. *Topics in geometric group theory*. ProQuest LLC, Ann Arbor, MI, 2010. Thesis (Ph.D.)—The University of Utah.
- [19] Walter D. Neumann. Immersed and virtually embedded π_1 -injective surfaces in graph manifolds. *Algebr. Geom. Topol.*, 1:411–426 (electronic), 2001.
- [20] Walter D. Neumann. On Leighton’s graph covering theorem. *Groups Geom. Dyn.*, 4(4):863–872, 2010.
- [21] Luisa Paoluzzi. The notion of commensurability in group theory and geometry. *RIMS Kôkyûroku*, 1836:124–137, 2013.
- [22] Emily Stark. Topological rigidity fails for quotients of the Davis complex. preprint 2016.
- [23] Emily Stark. Abstract commensurability and quasi-isometry classification of hyperbolic surface group amalgams. *Geometriae Dedicata*, pages 1–36, 2016.
- [24] Genevieve S. Walsh. Orbifolds and commensurability. In *Interactions between hyperbolic geometry, quantum topology and number theory*, volume 541 of *Contemp. Math.*, pages 221–231. Amer. Math. Soc., Providence, RI, 2011.